

EVOTECH®
P E R F O R M A N C E

www.evotech-performance.com

Aprilia RSV4 Radiator Guard Set

Installation Instructions



Kit Contents PRN08163-008164

- (A) 1 x Radiator Guard
- (B) 1 x Oil Cooler Guard
- (C) 2 x Mounting Brackets
- (D) 2 x Zip Ties
- (E) 2 x M6 - 16 Socket Button Head Screw
- (F) 2 x M6 - 25 Socket Button Head Screw
- (G) 2 x M6 Washers
- (H) 2 x M6 Special Washers
- (I) 4 x M4 - 10 Socket Button Head Screws
- (J) 4 x 5mm Neoprene
- (K) 6 x 3mm Neoprene

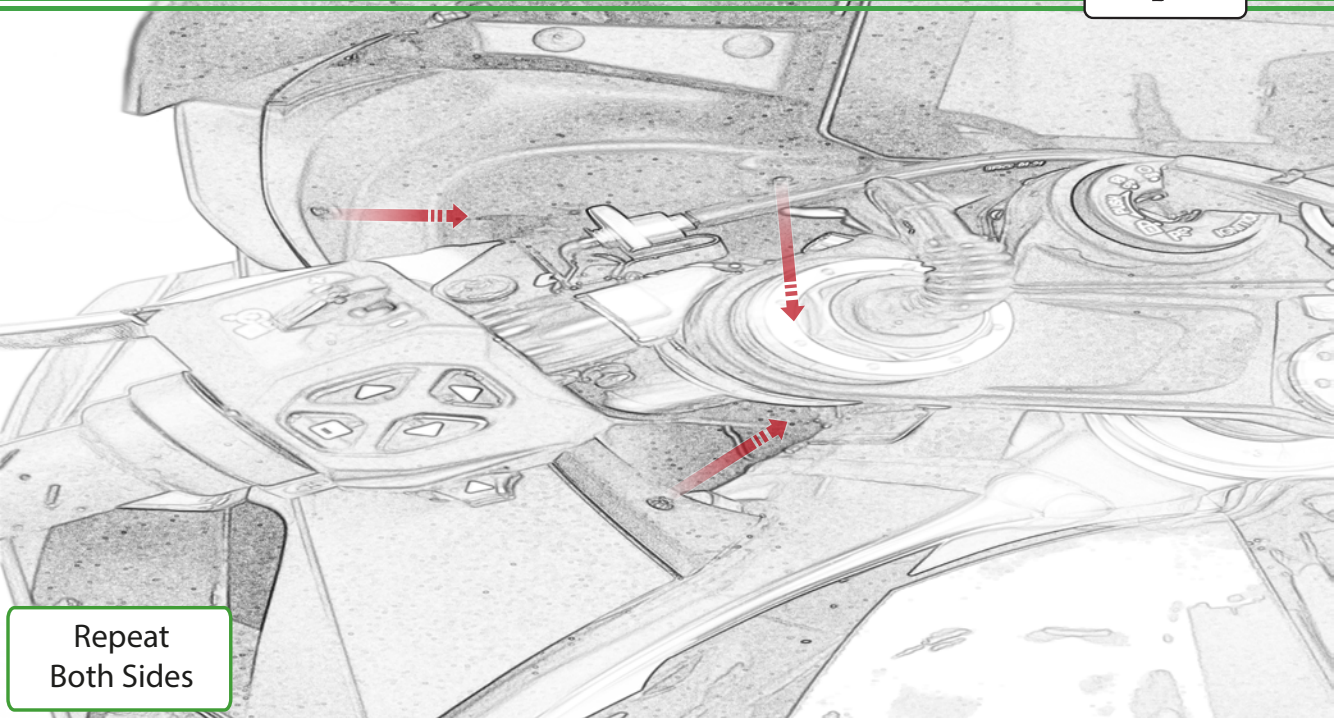

Repeat
Both Sides

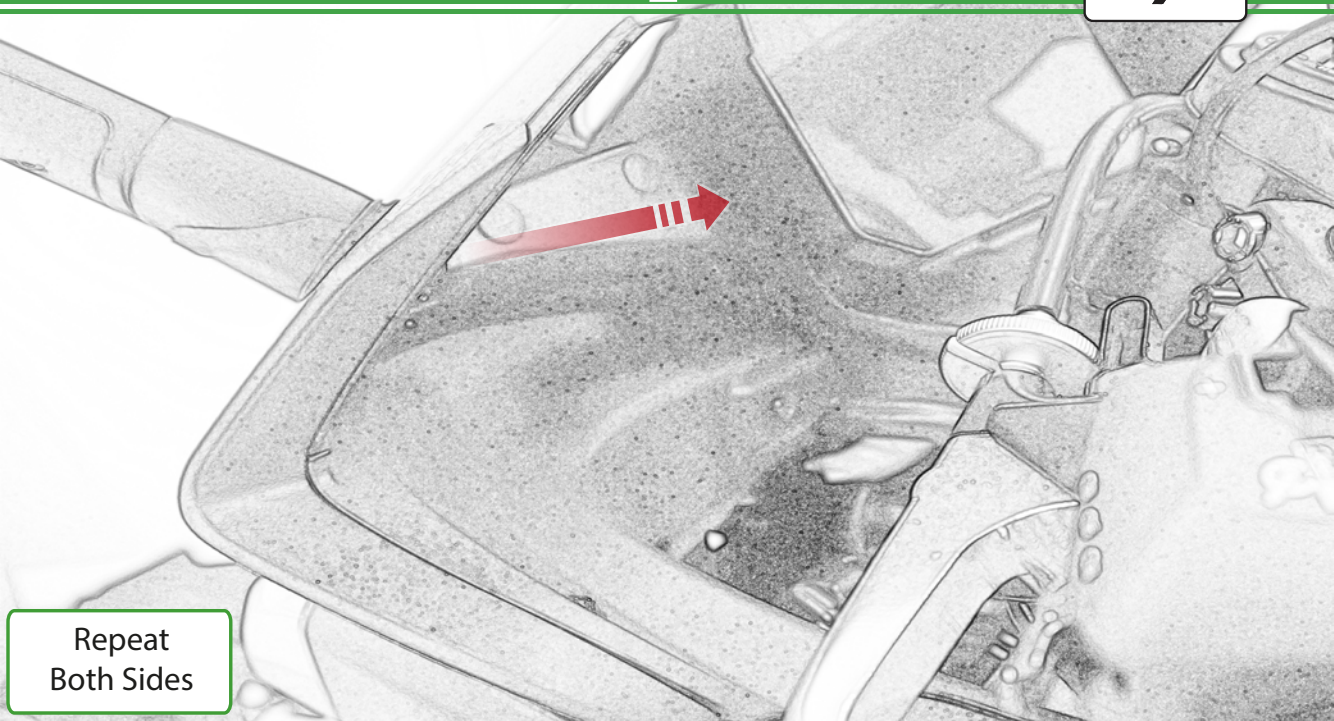

Repeat
Both Sides

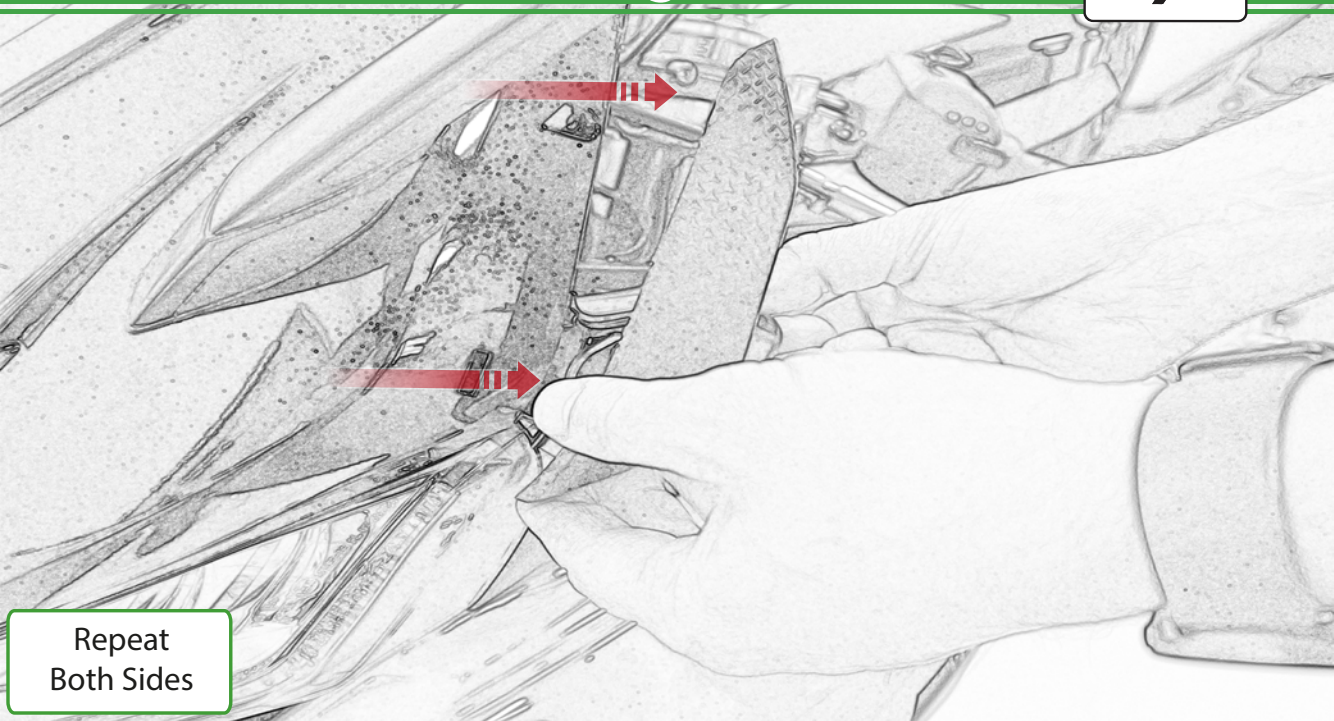

Repeat
Both Sides

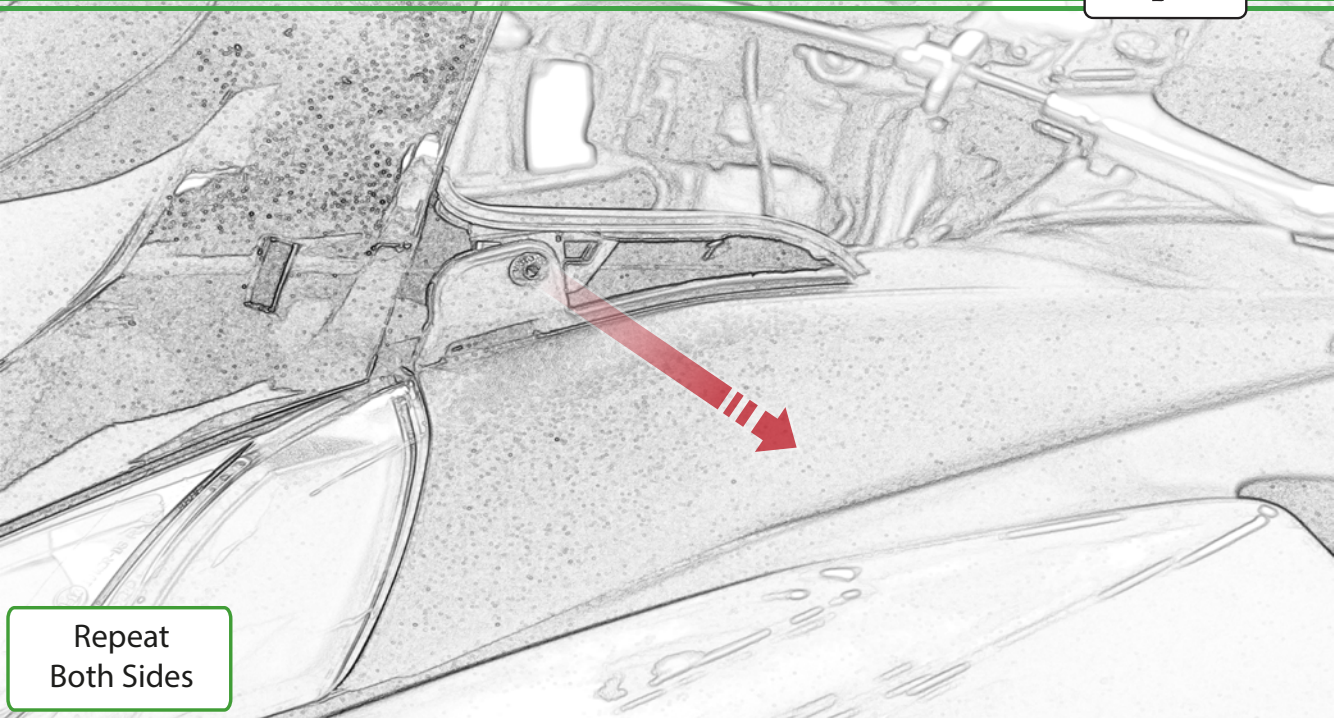

Repeat
Both Sides

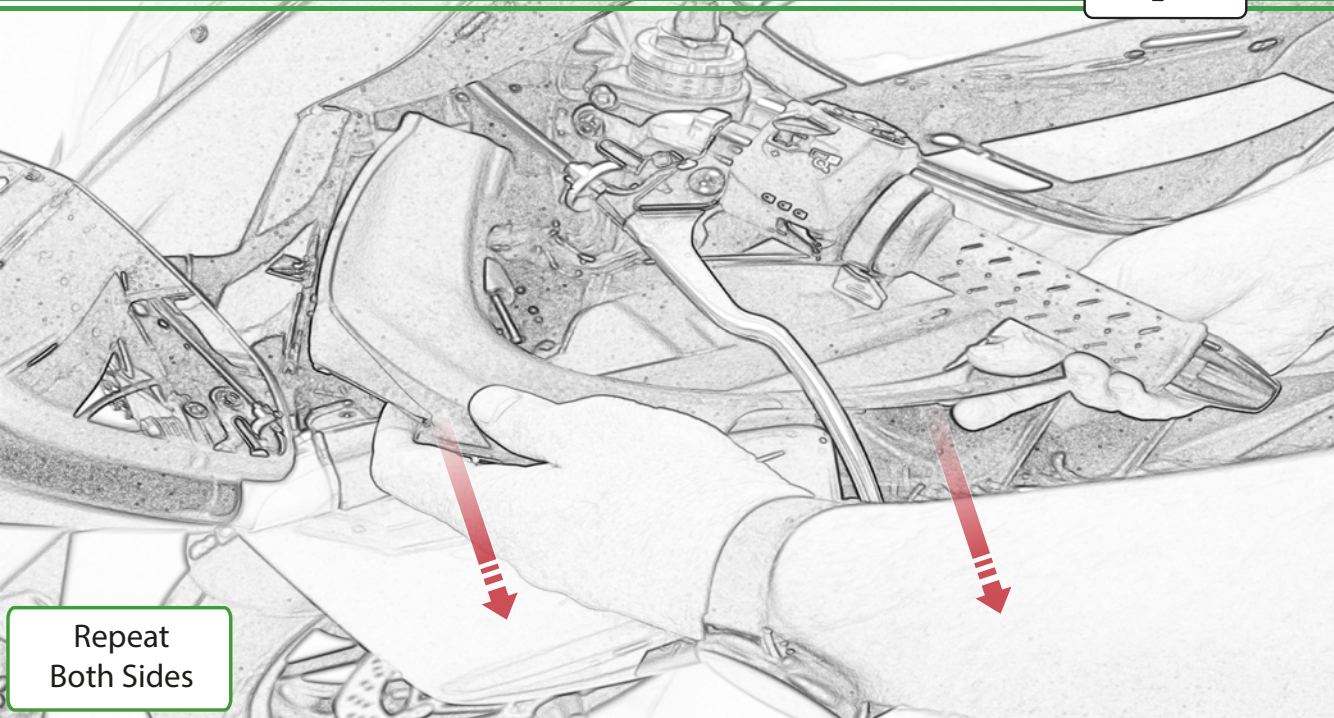

Repeat
Both Sides

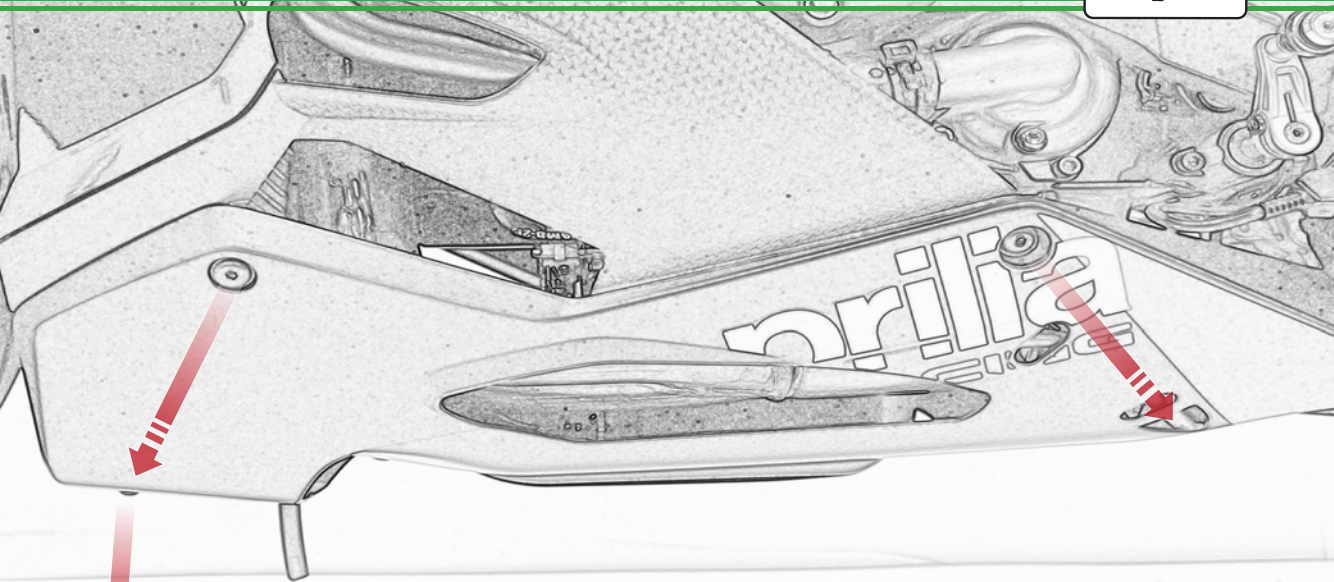

Repeat
Both Sides

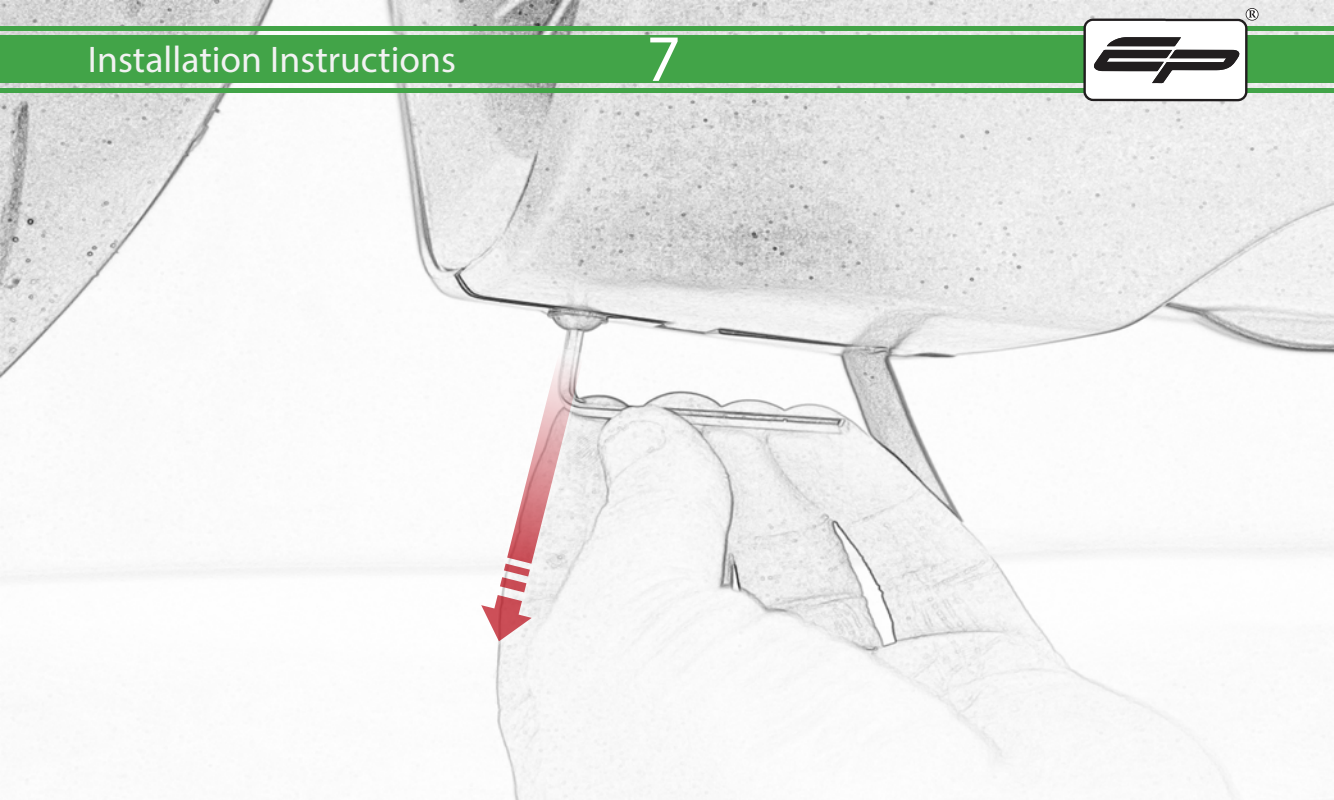

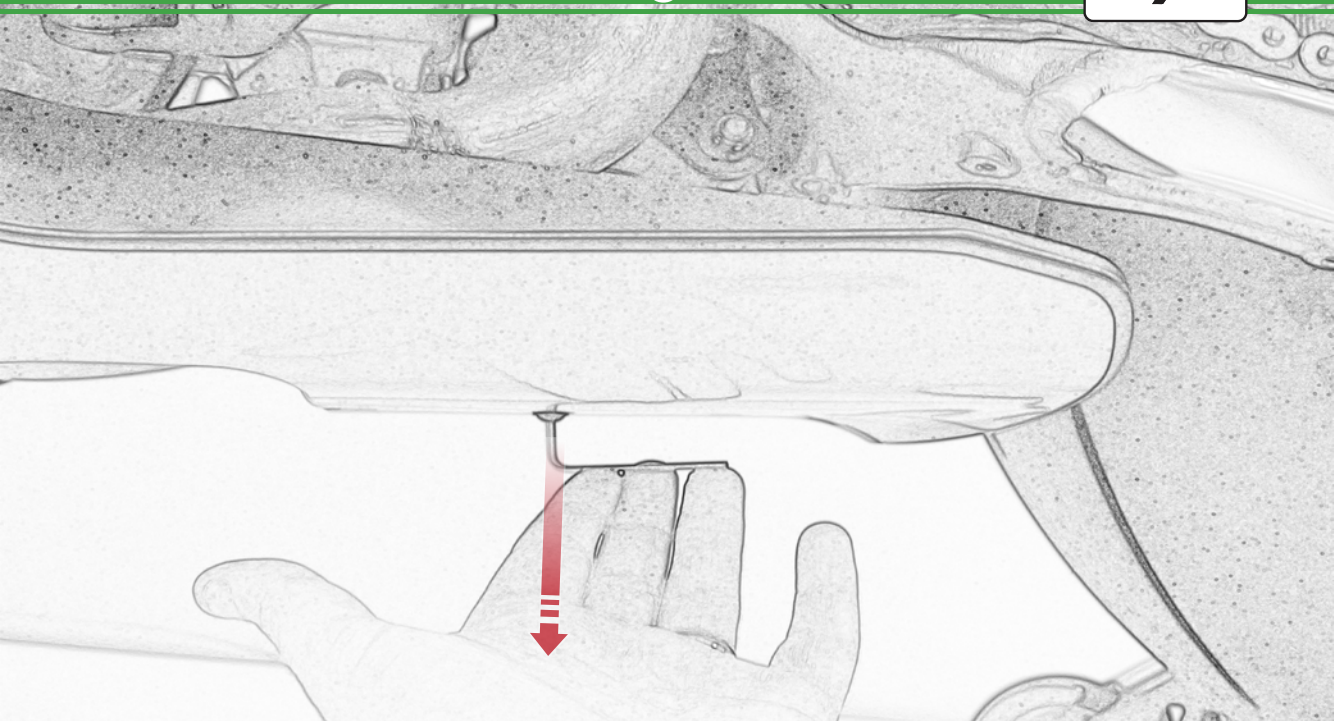

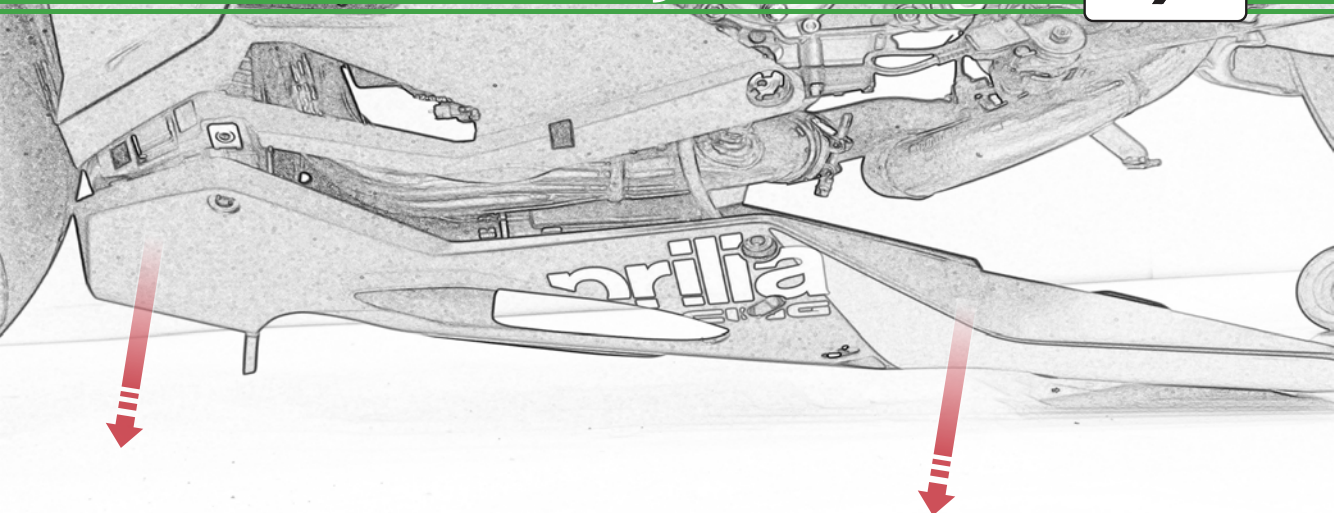

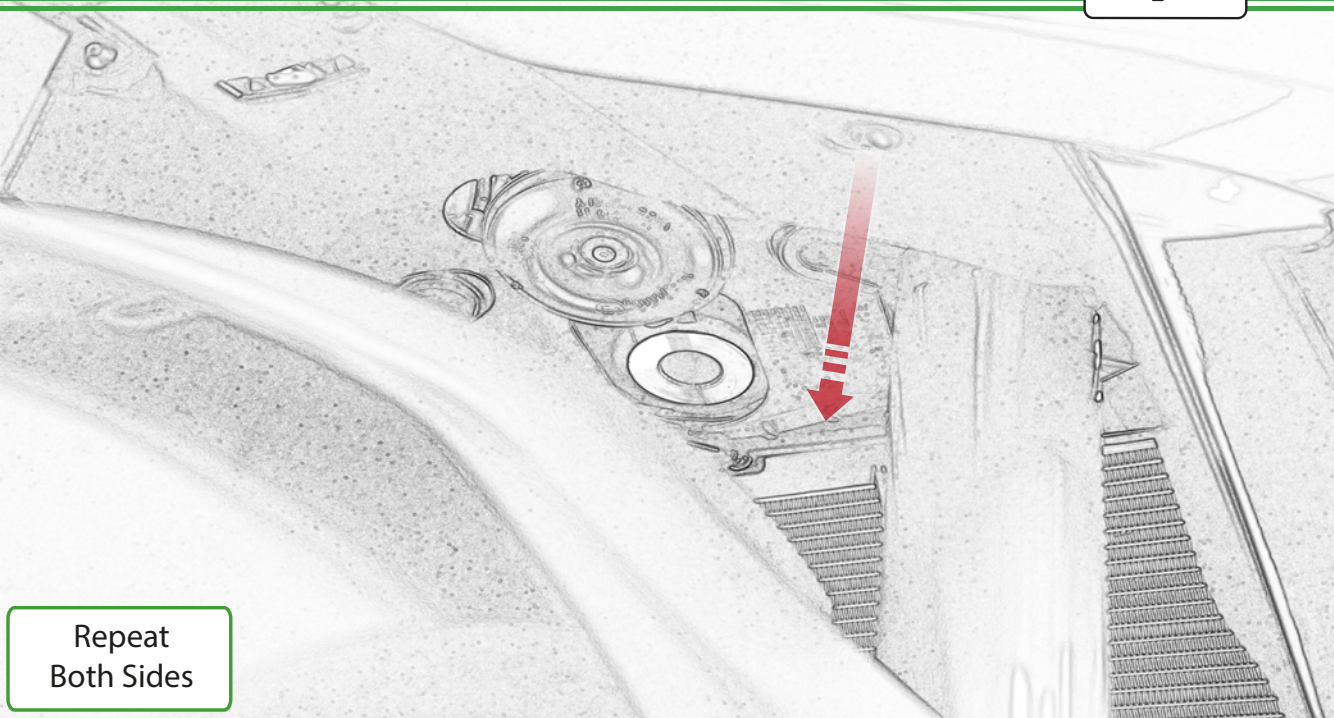

Repeat
Both Sides

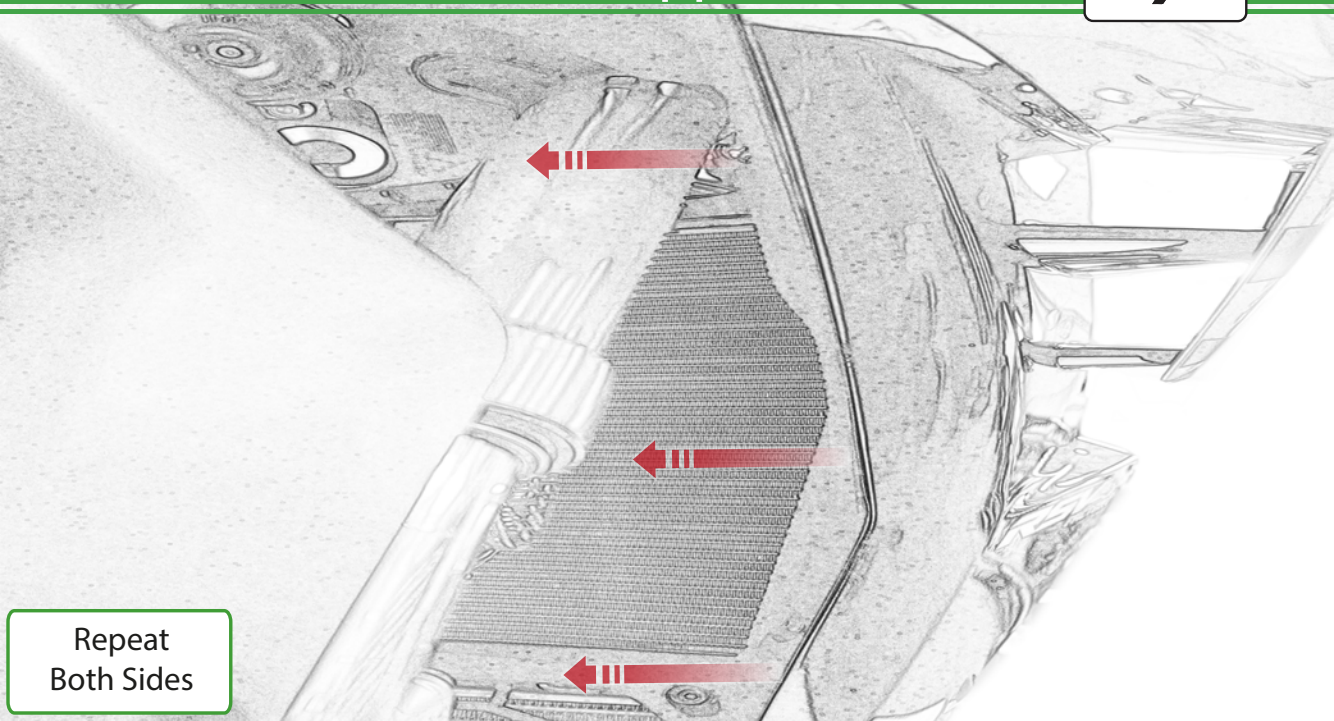

Repeat
Both Sides

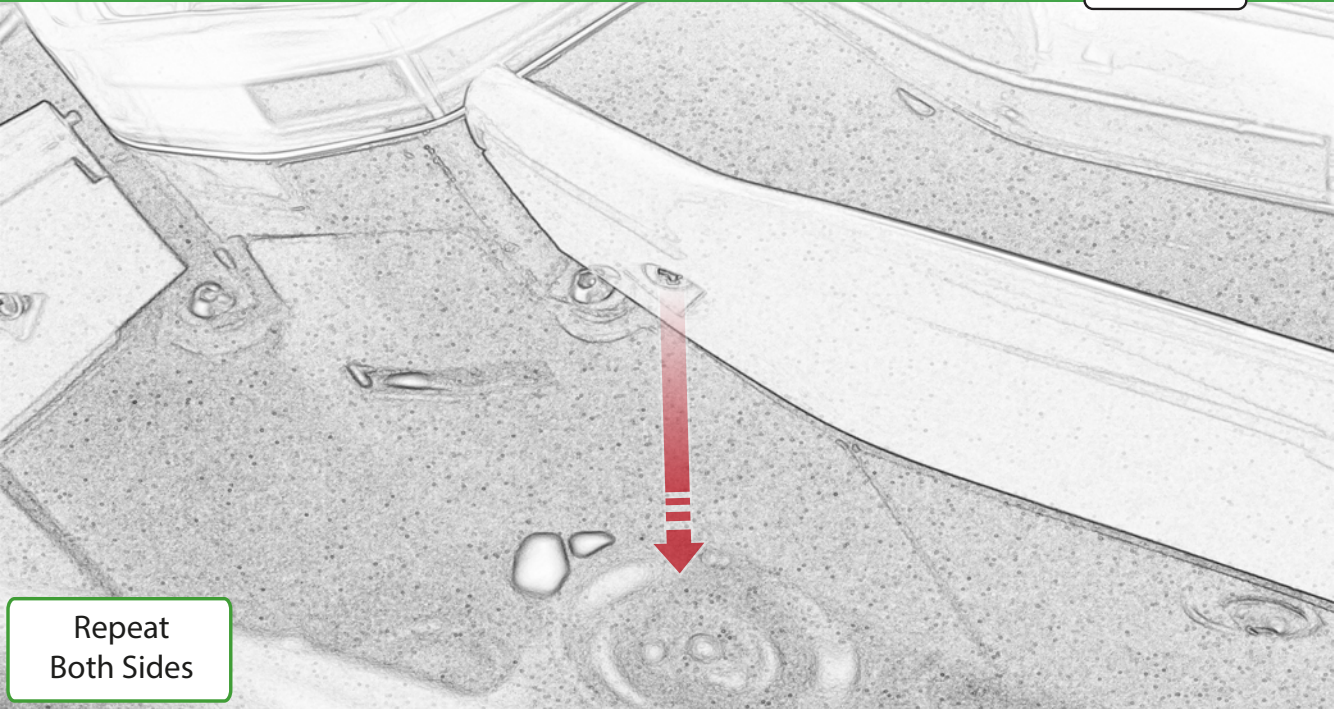

Repeat
Both Sides

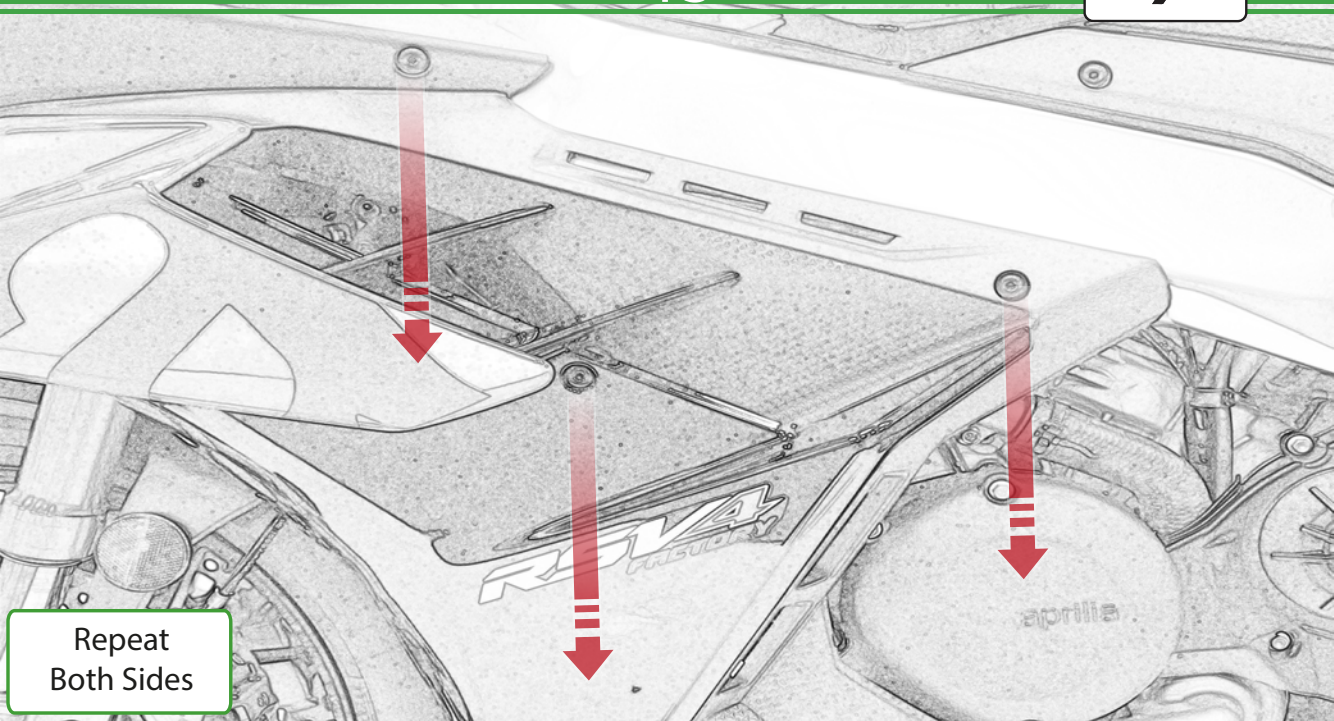

Repeat
Both Sides

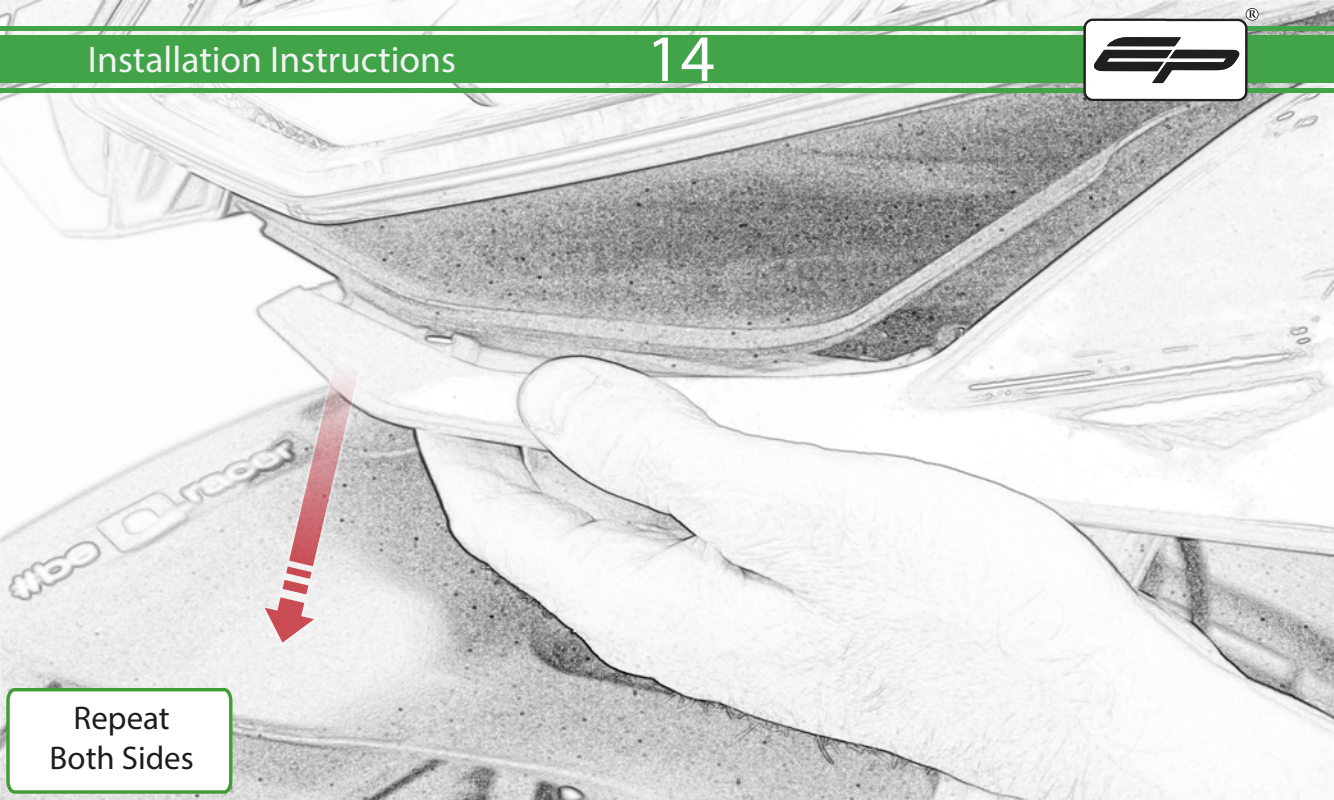

Repeat
Both Sides

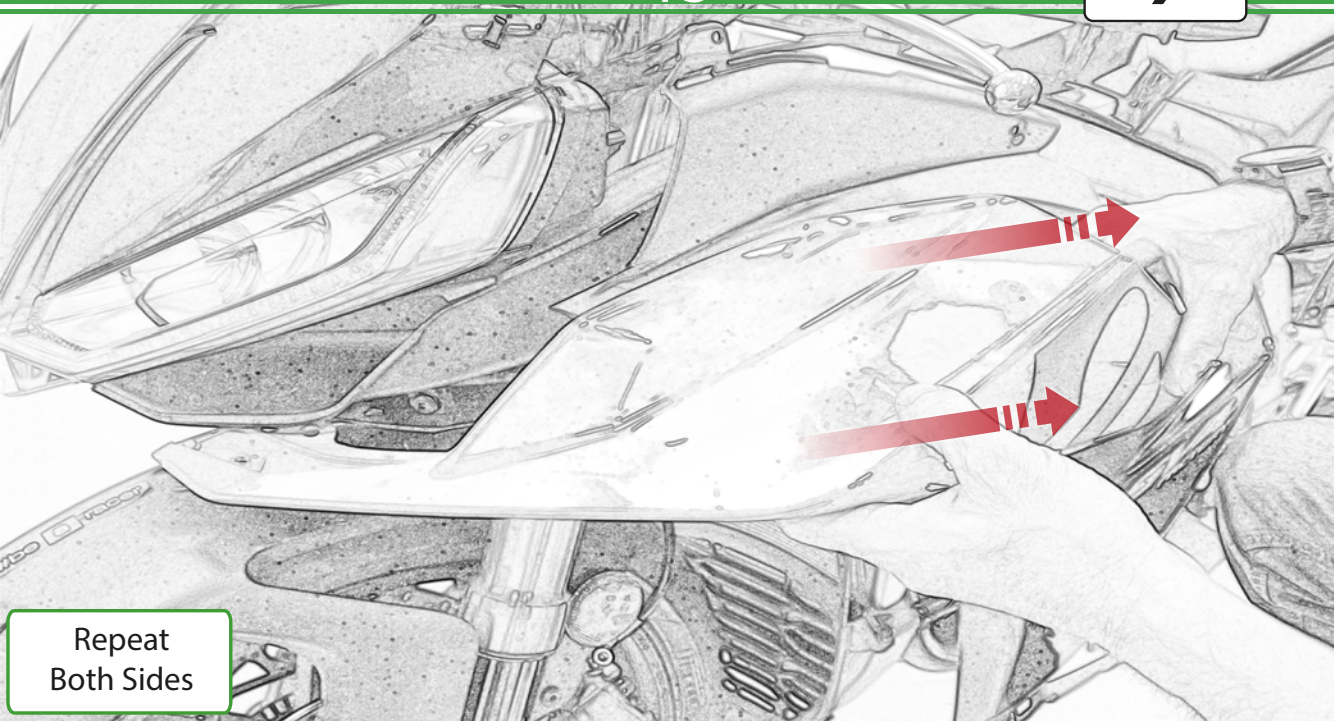

Repeat
Both Sides

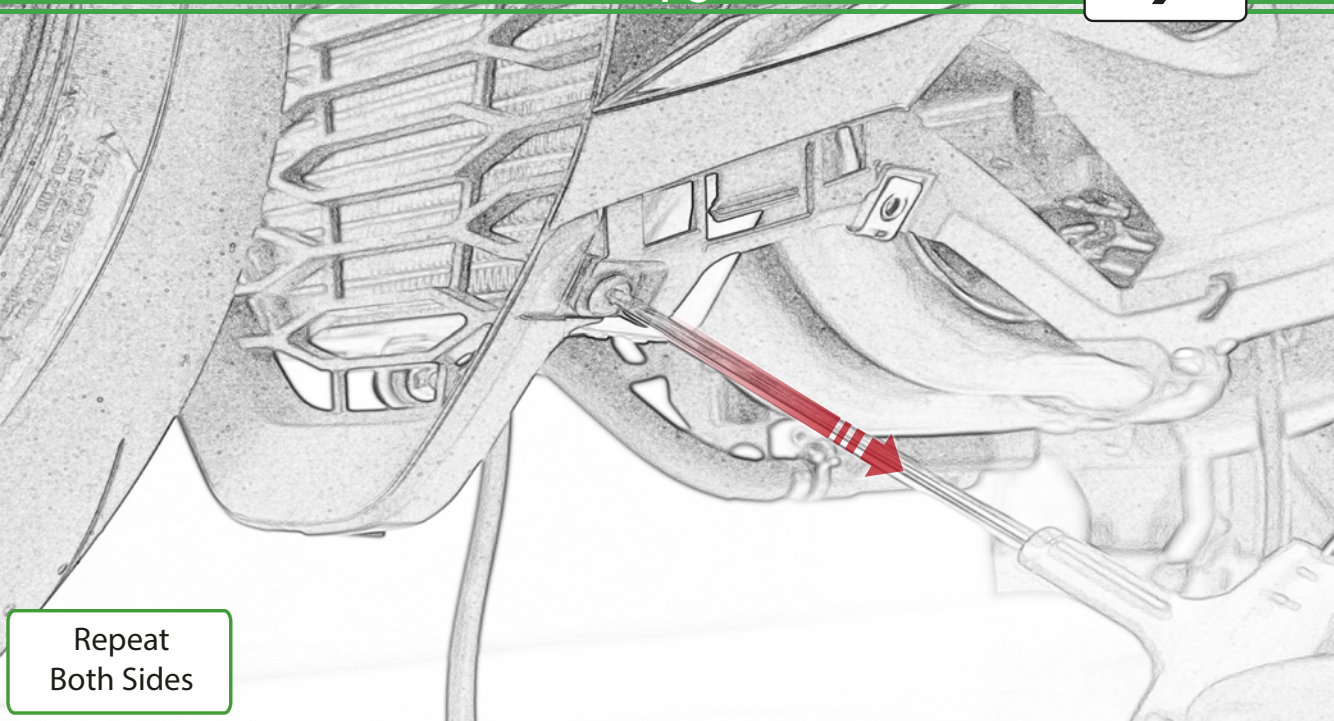

Repeat
Both Sides

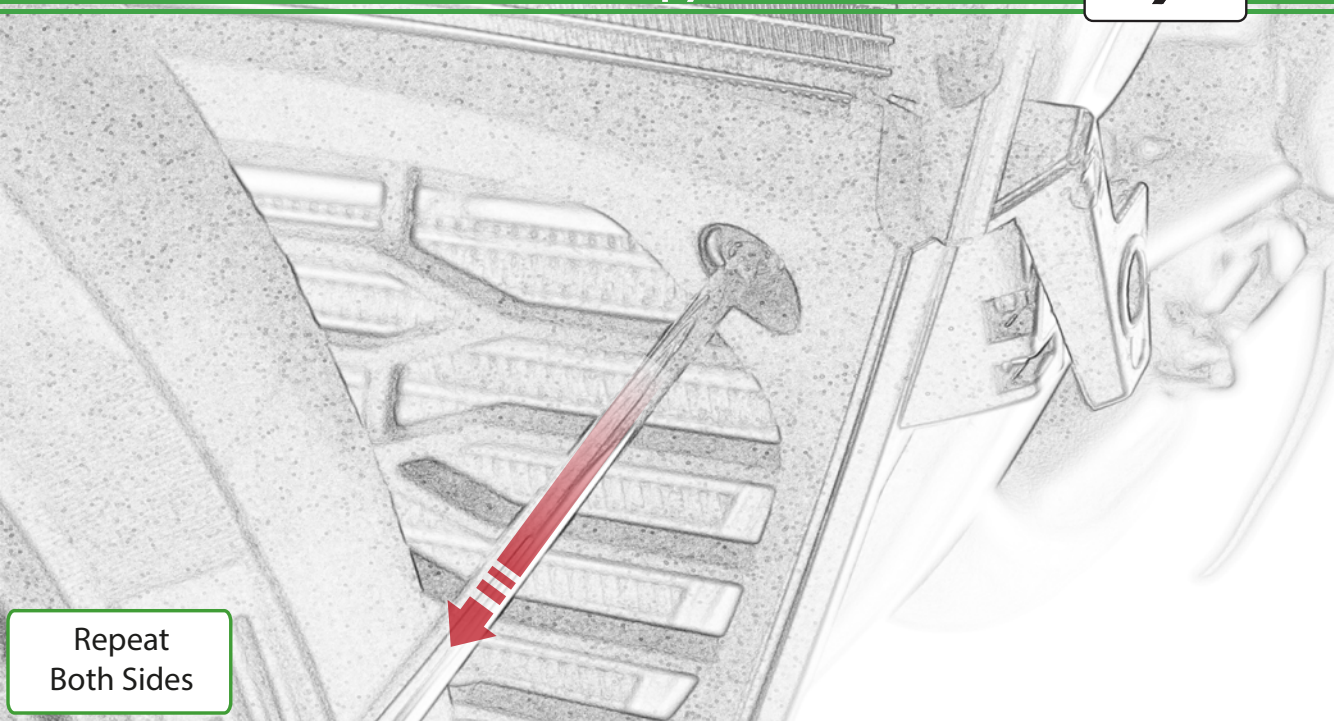

Repeat
Both Sides

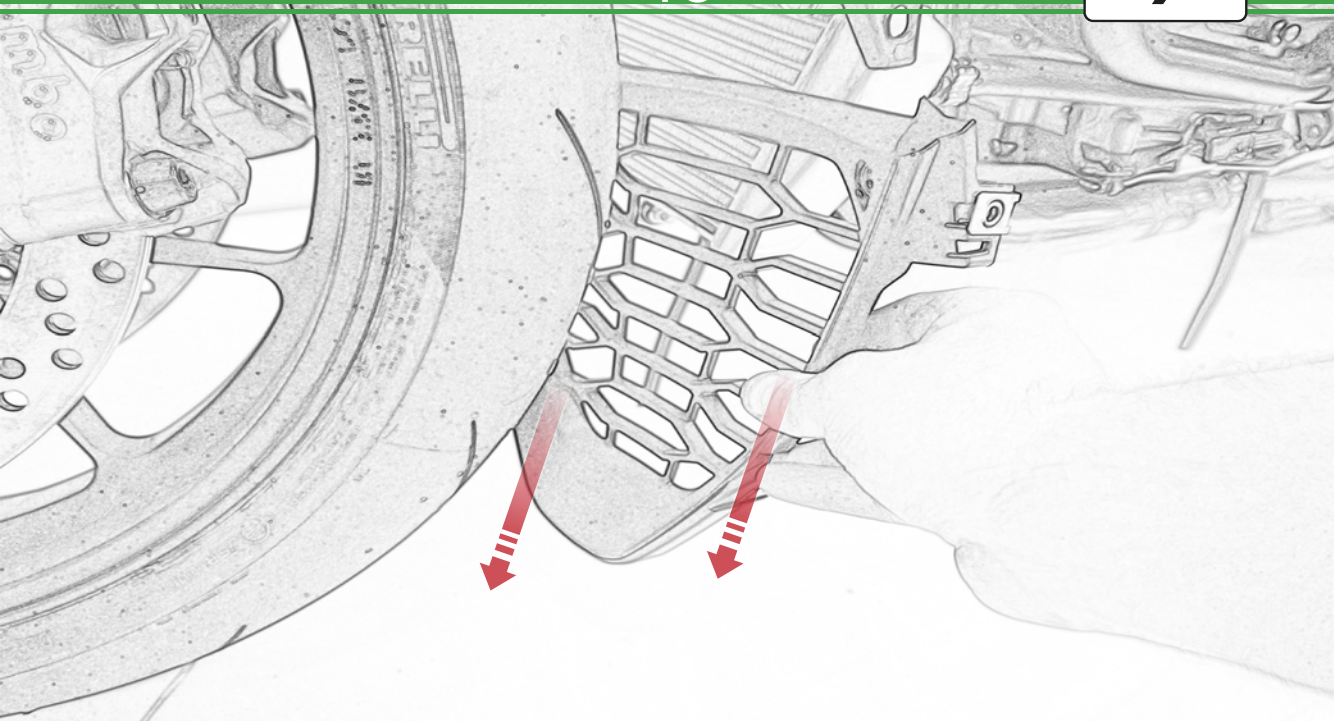

Repeat
Both Sides

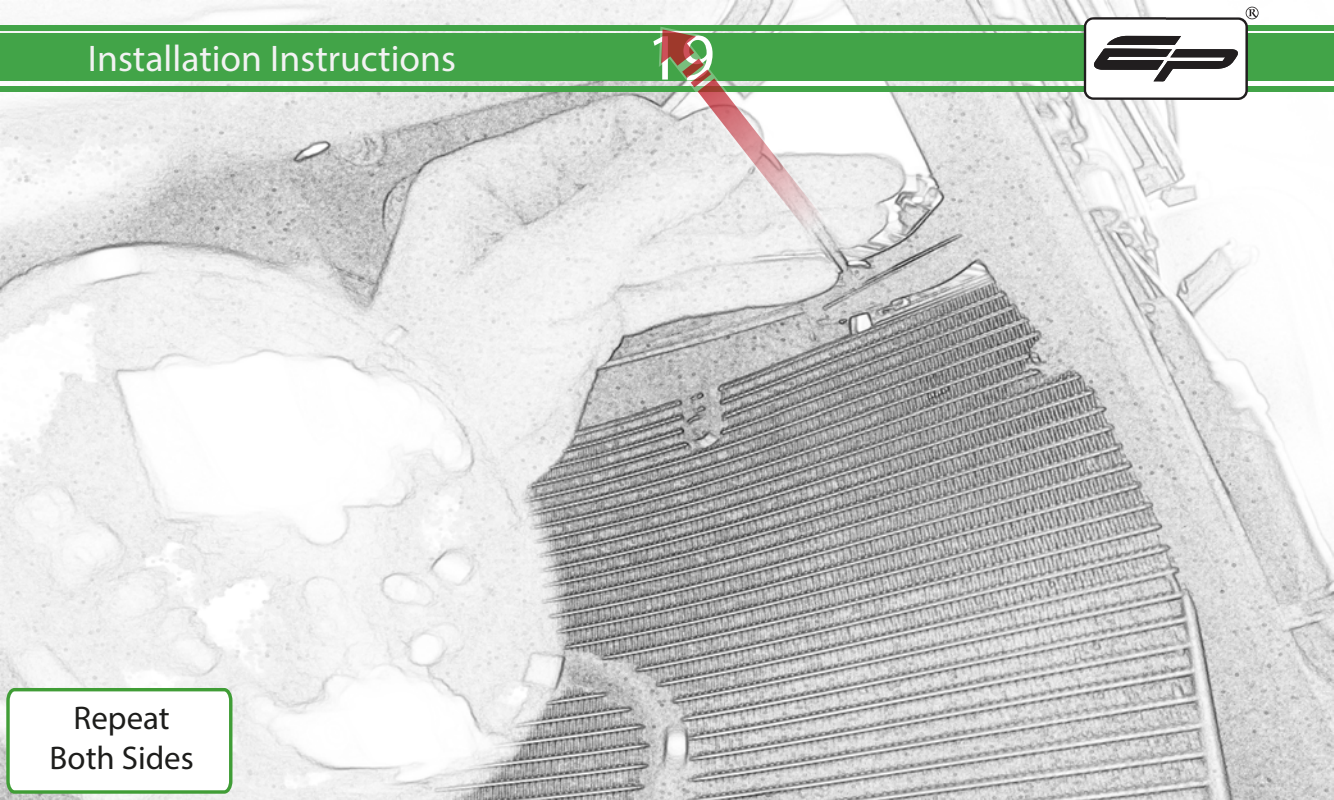

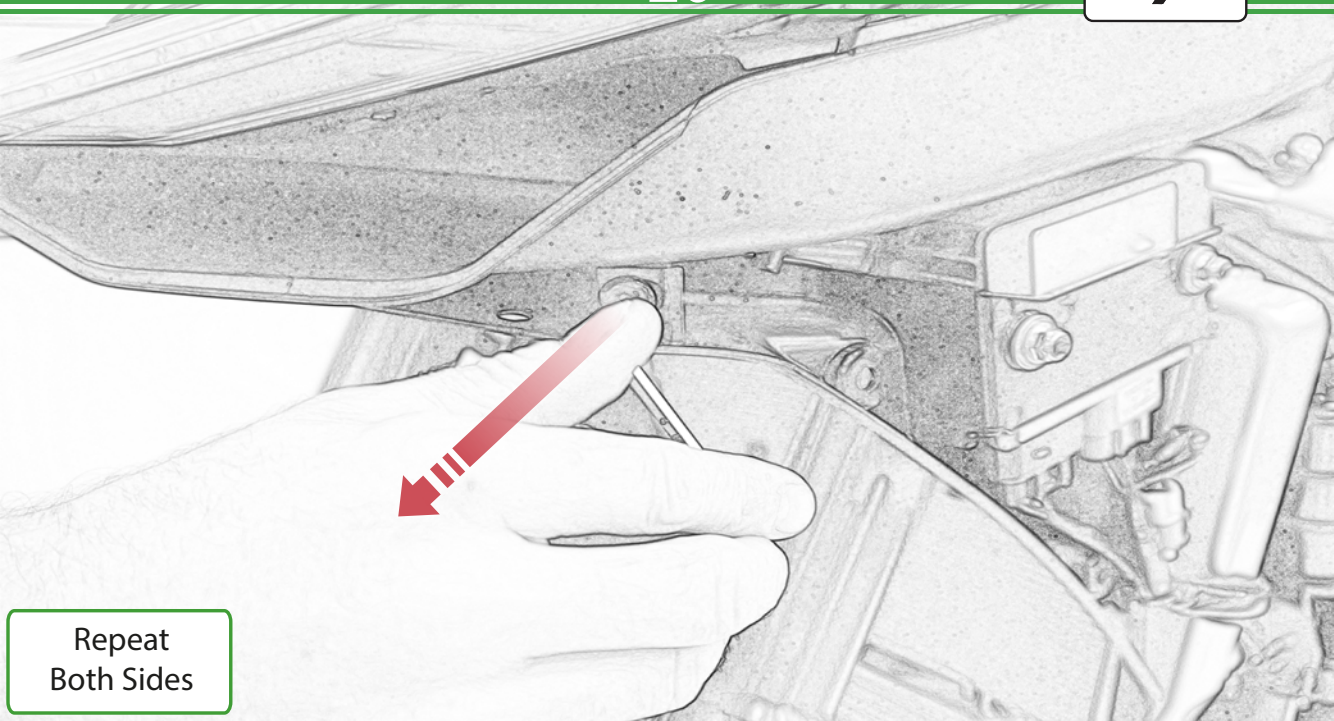

Repeat
Both Sides

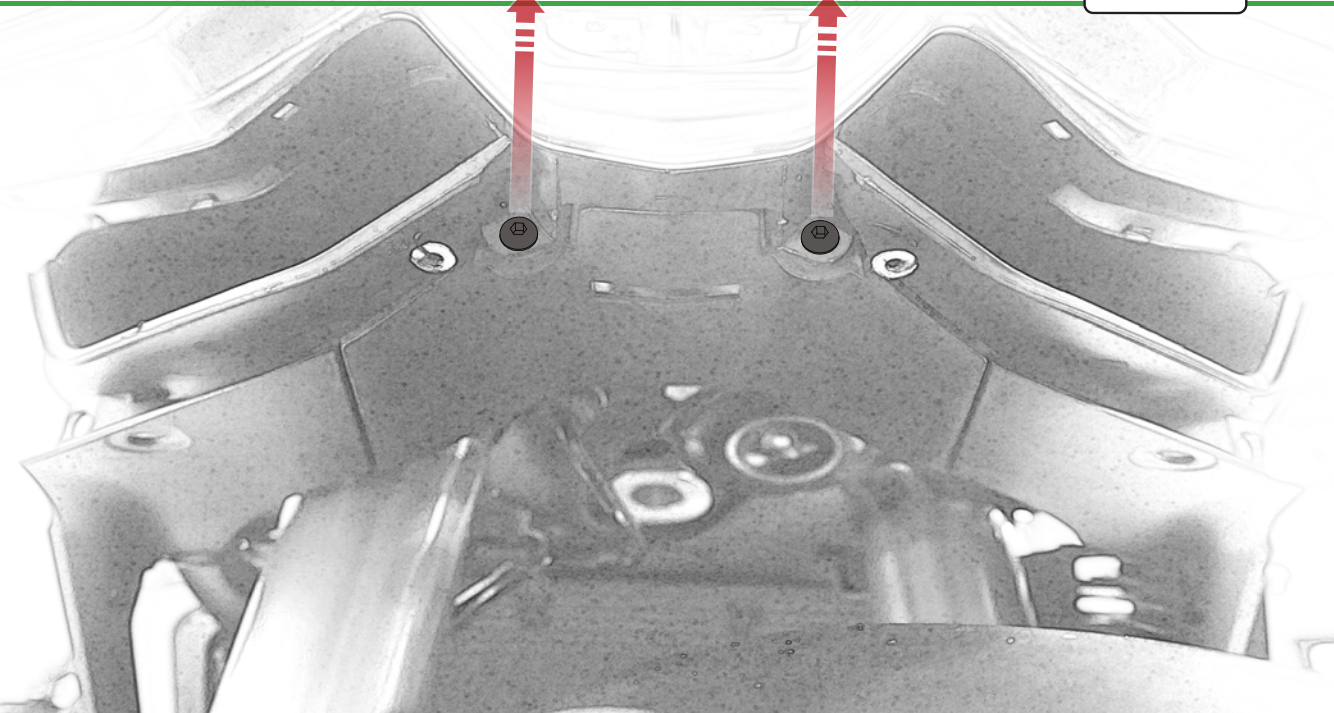

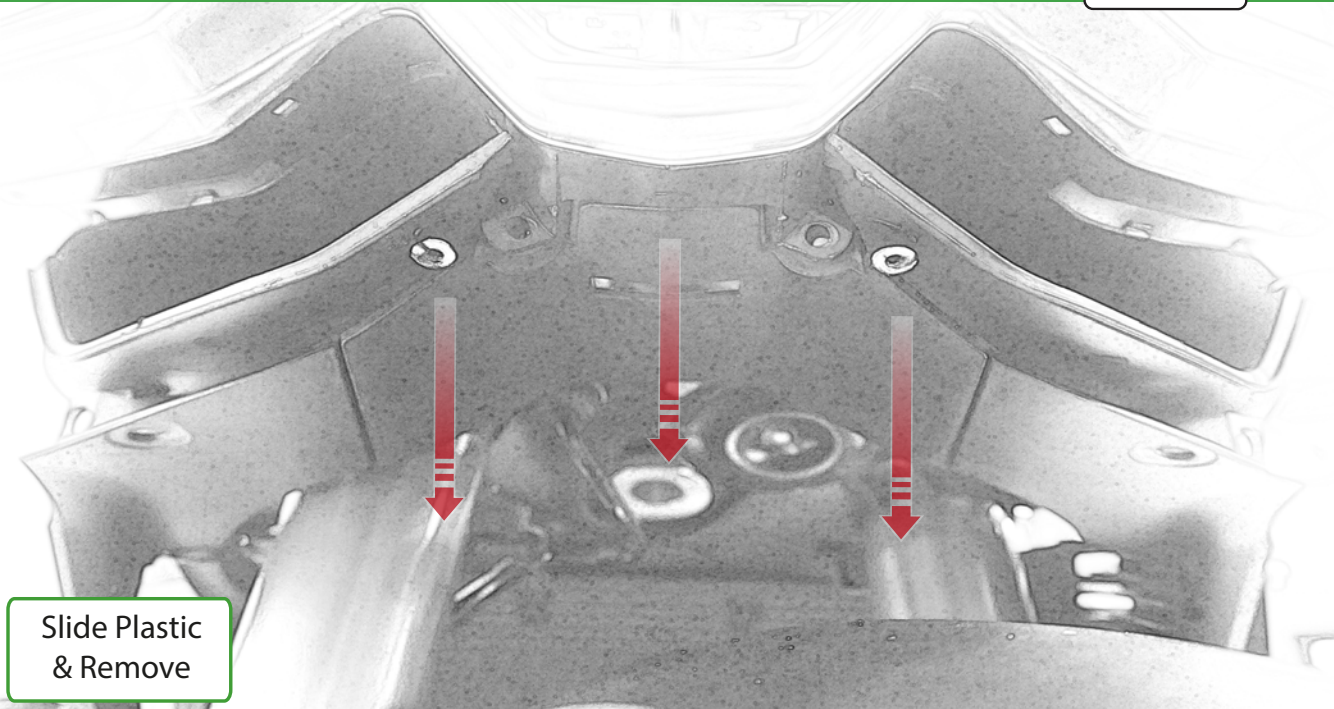

Slide Plastic
& Remove

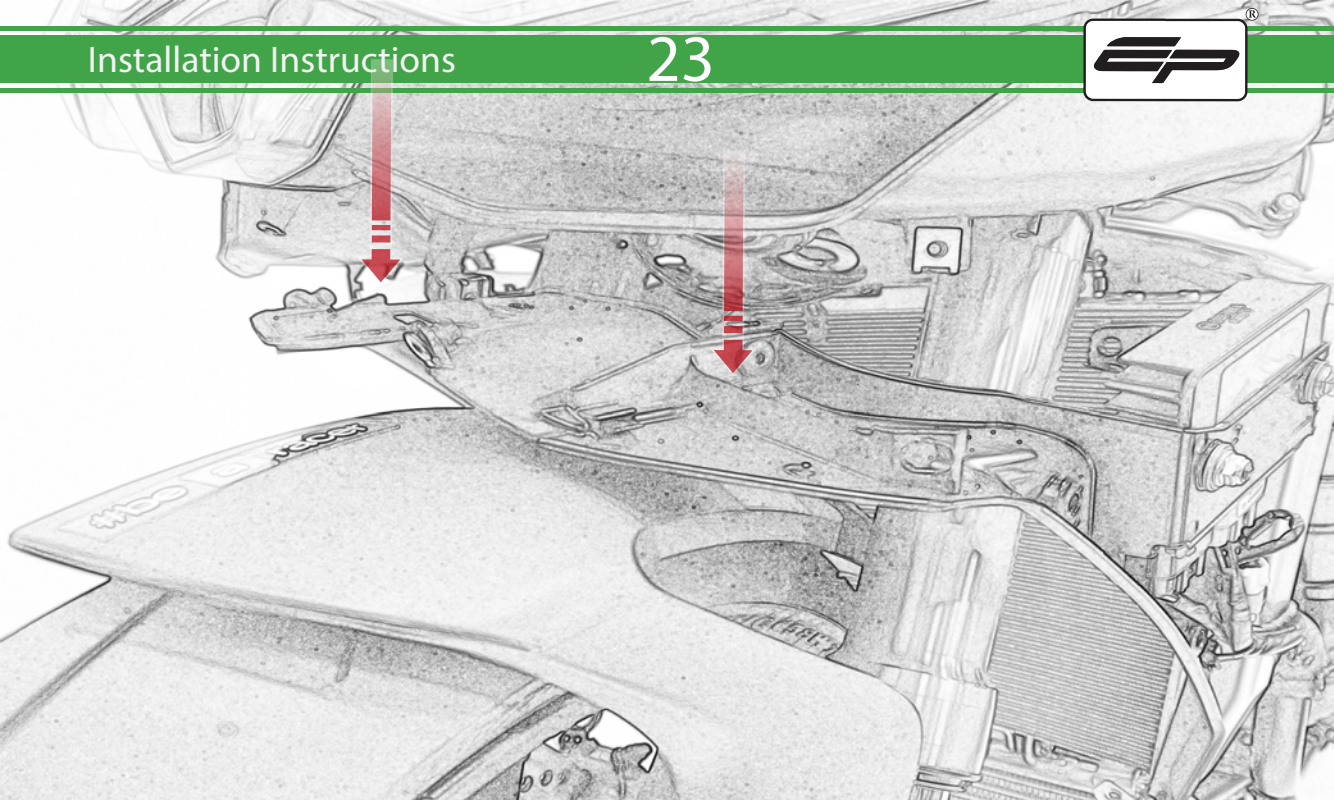

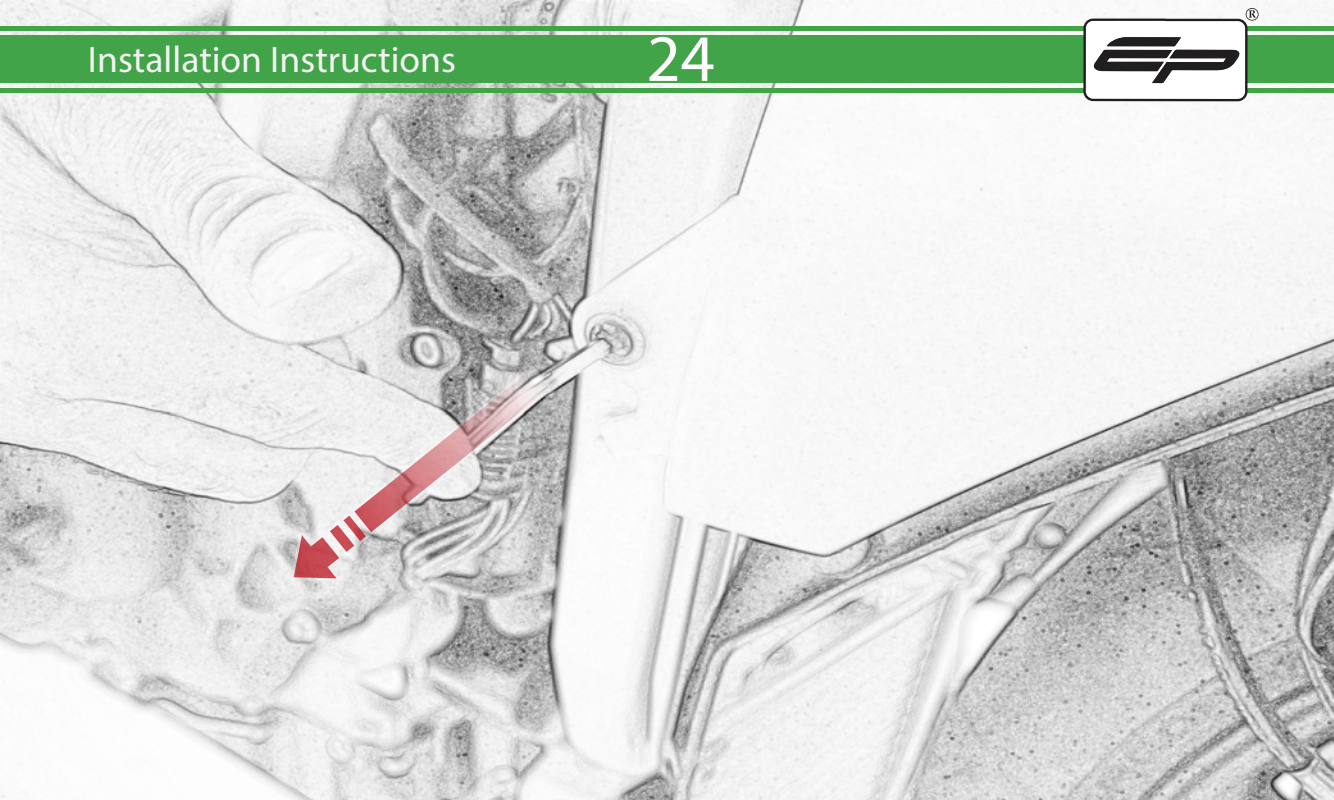

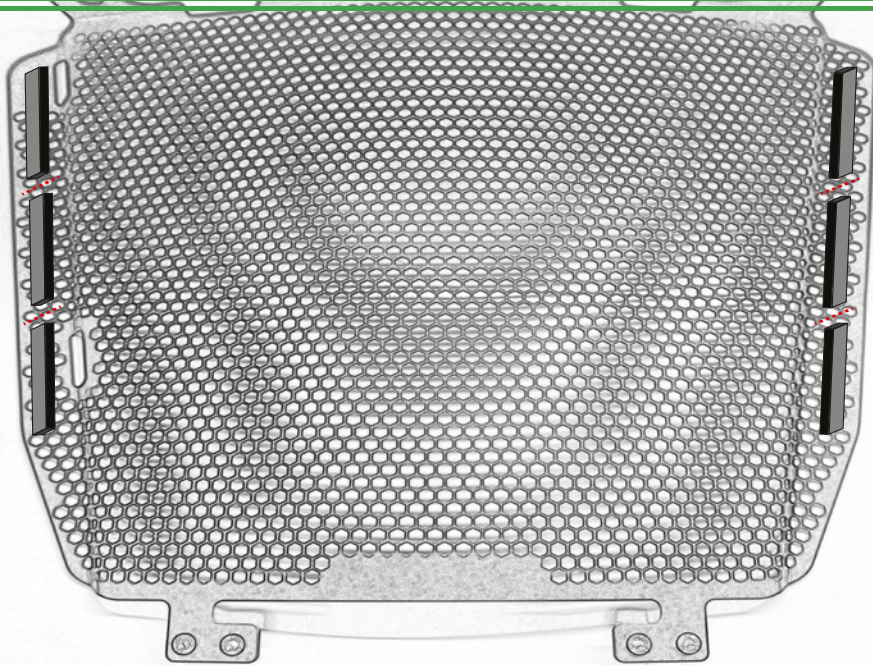

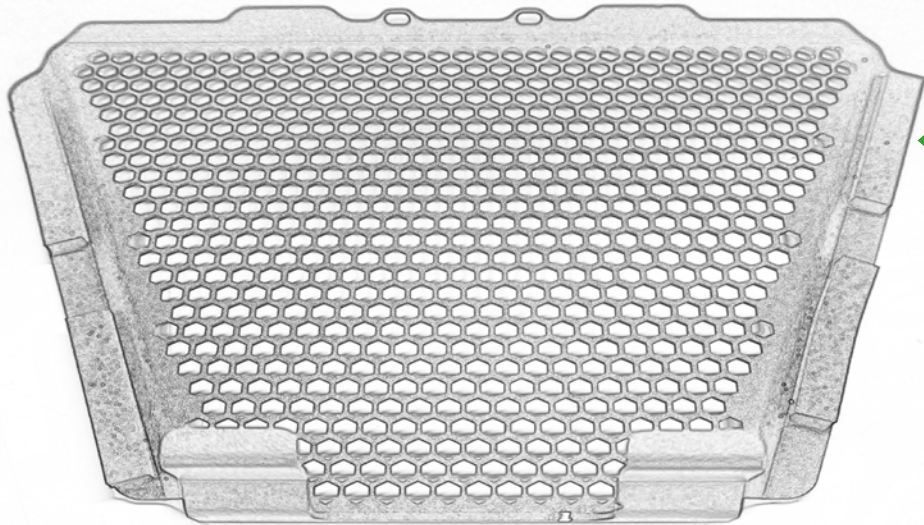

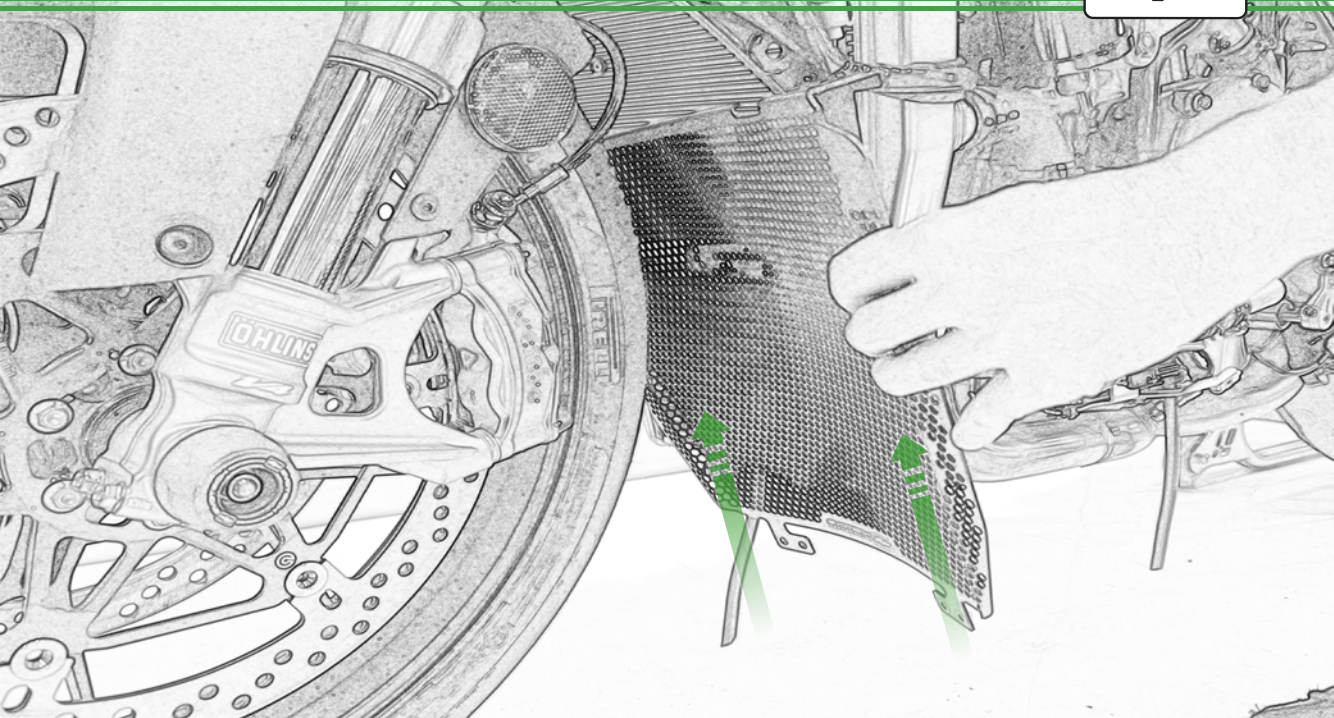

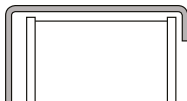
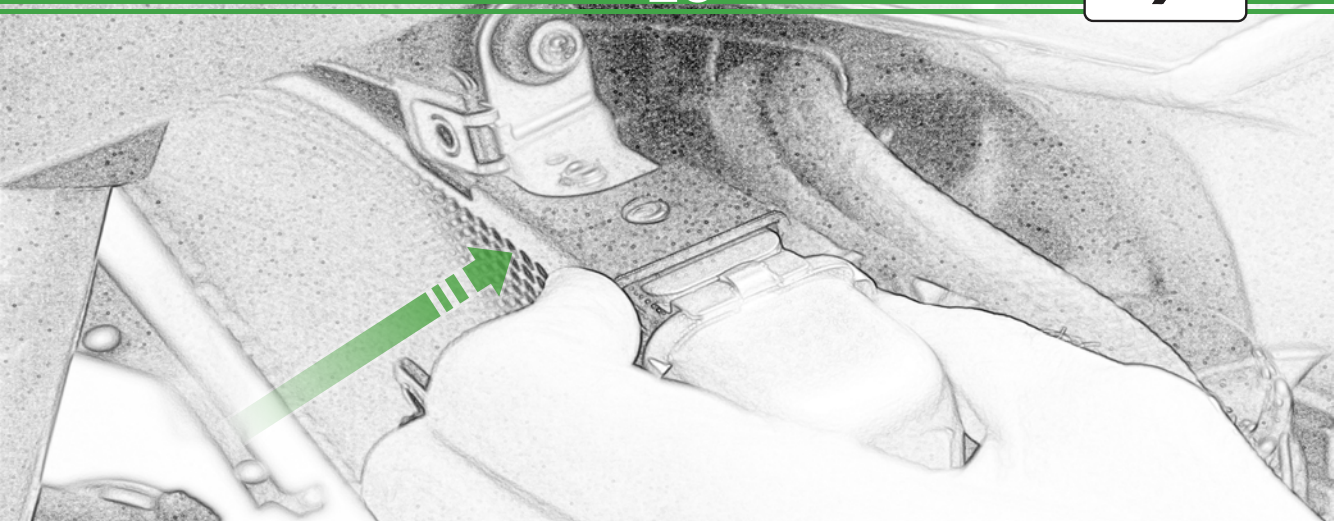

Ensure the radiator guard
securely hooks over the
top lip of the radiator



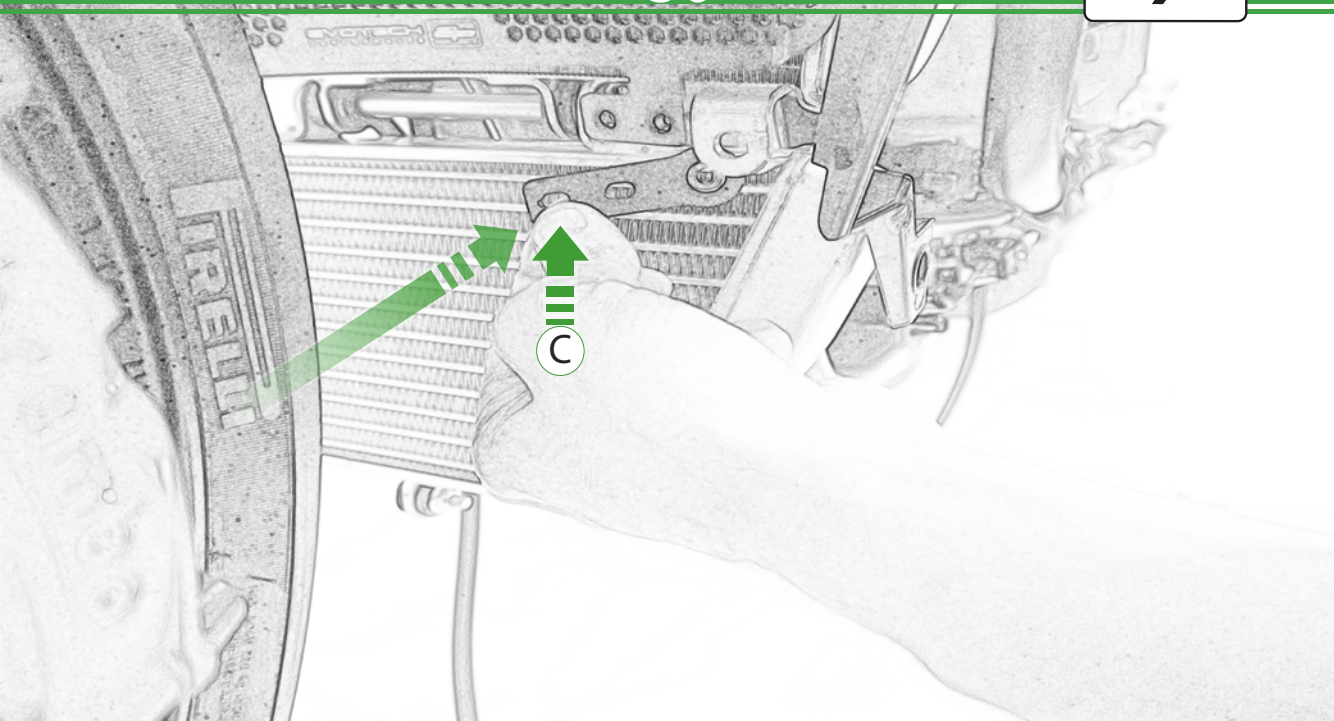

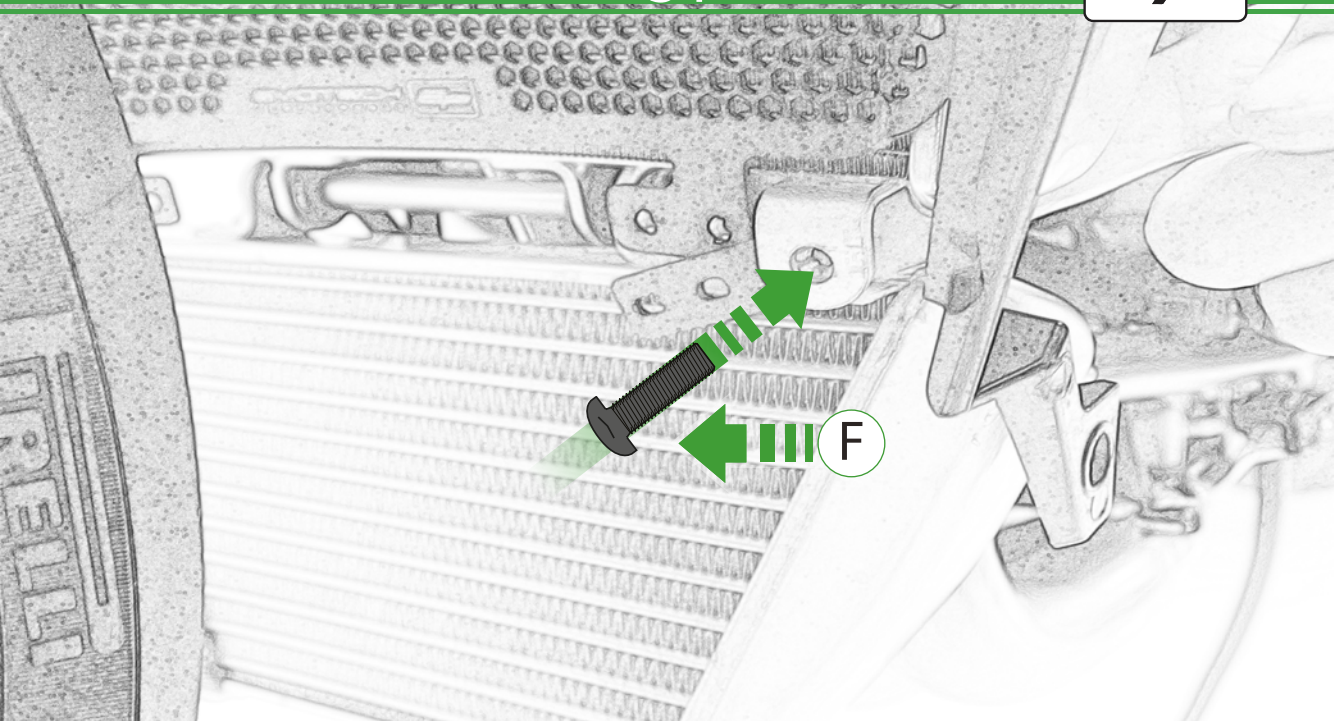

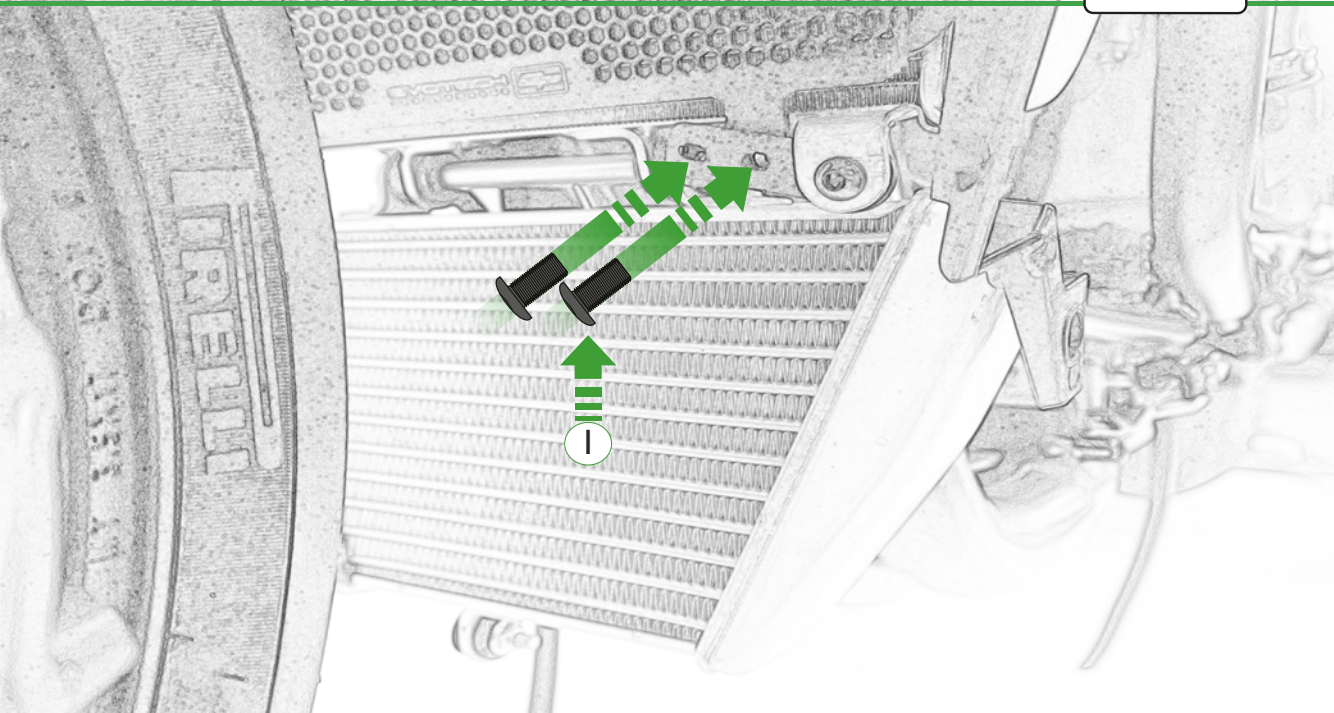

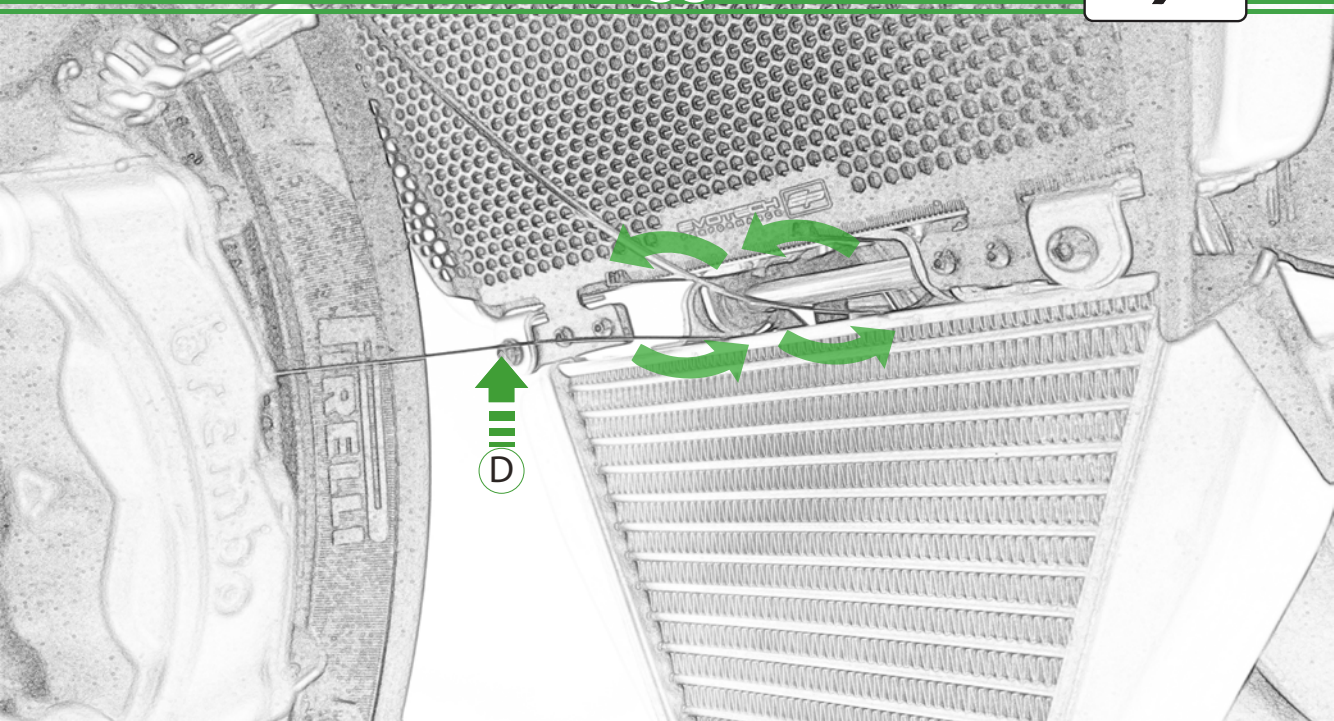

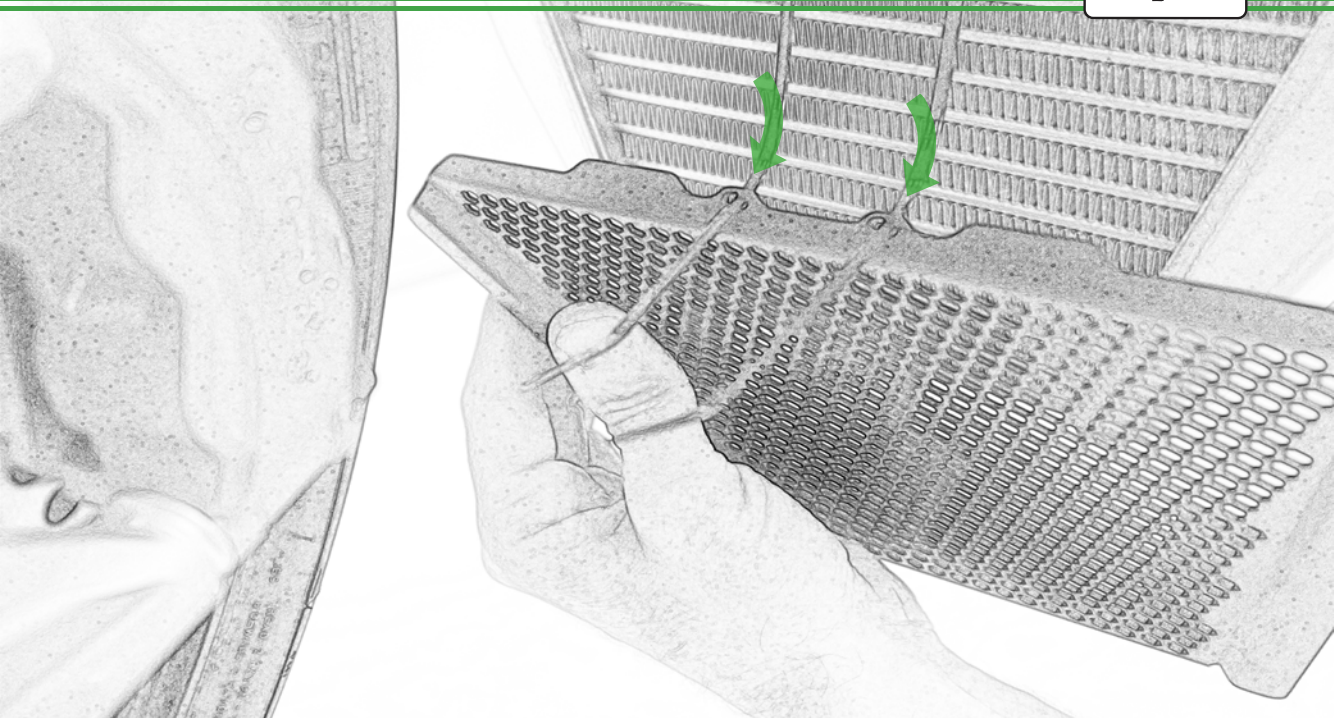

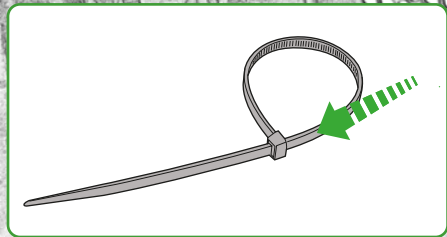
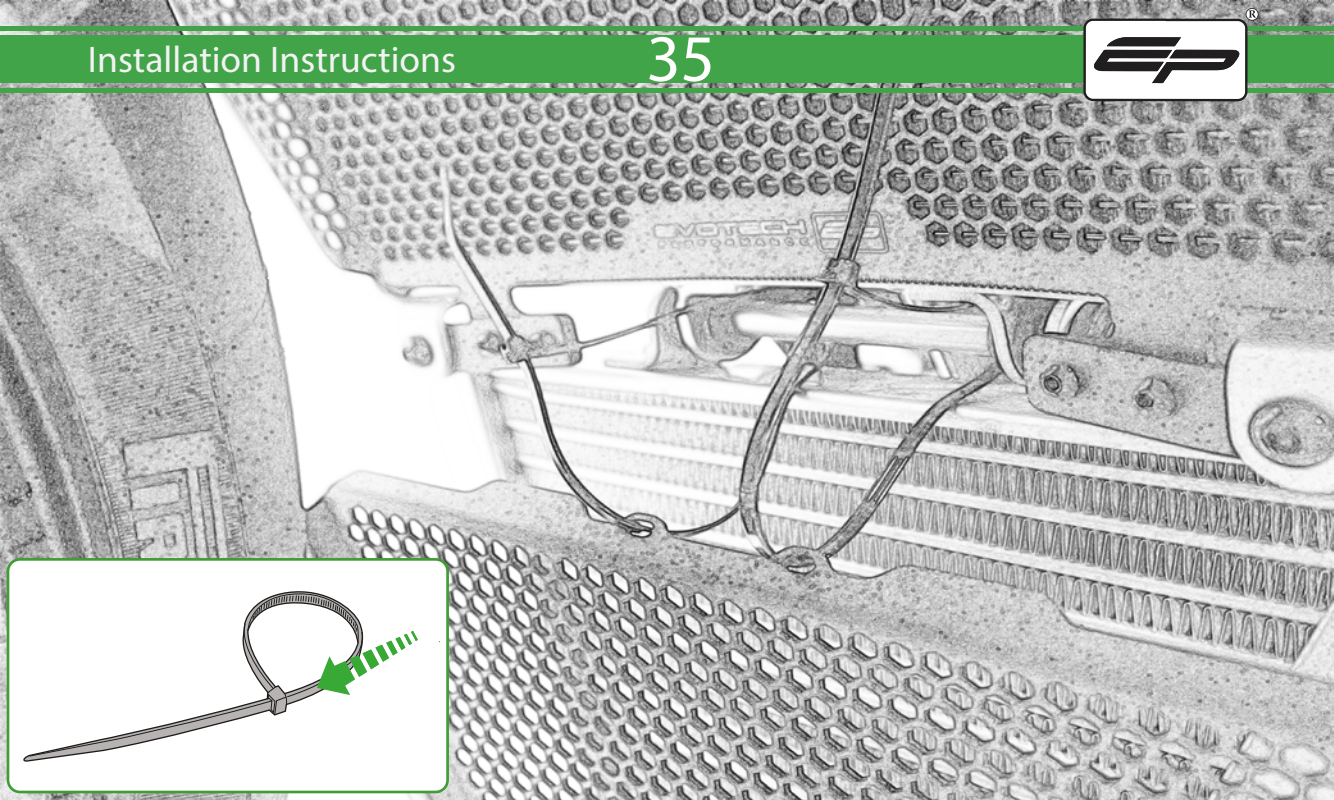

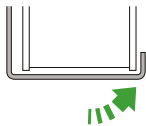
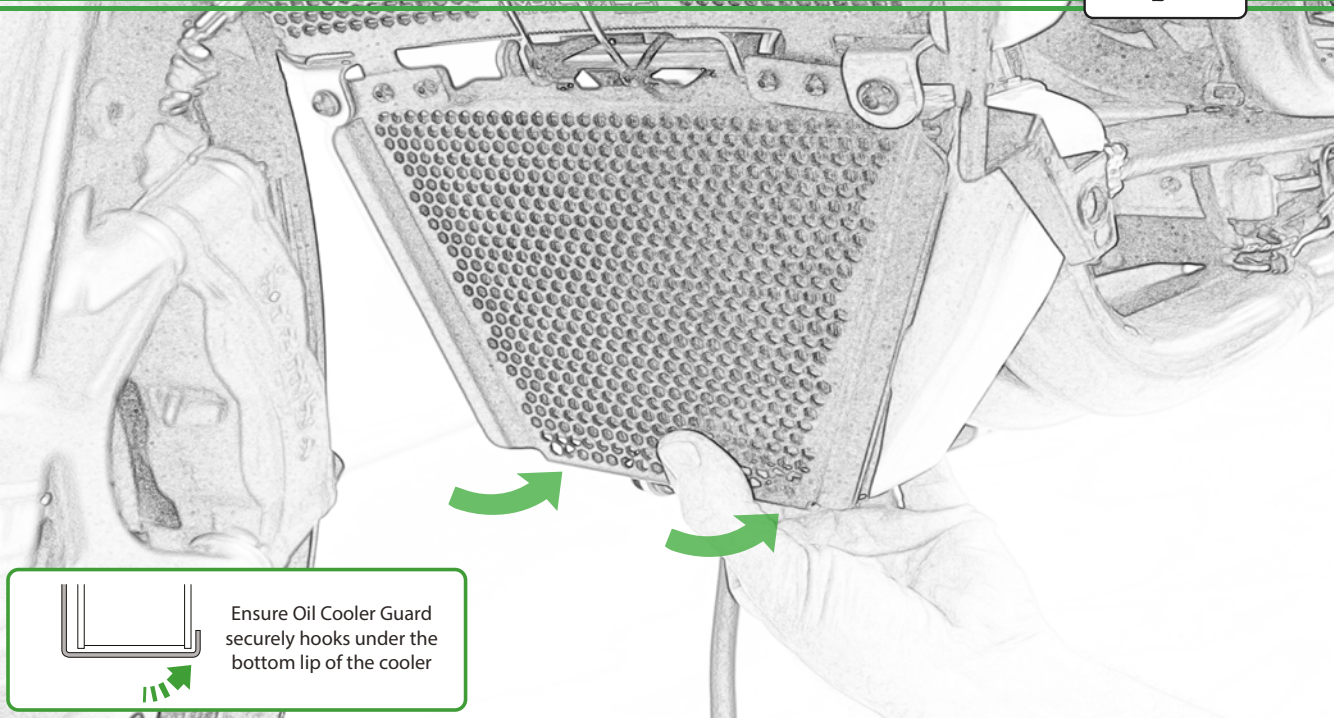

Ensure Oil Cooler Guard
securely hooks under the
bottom lip of the cooler

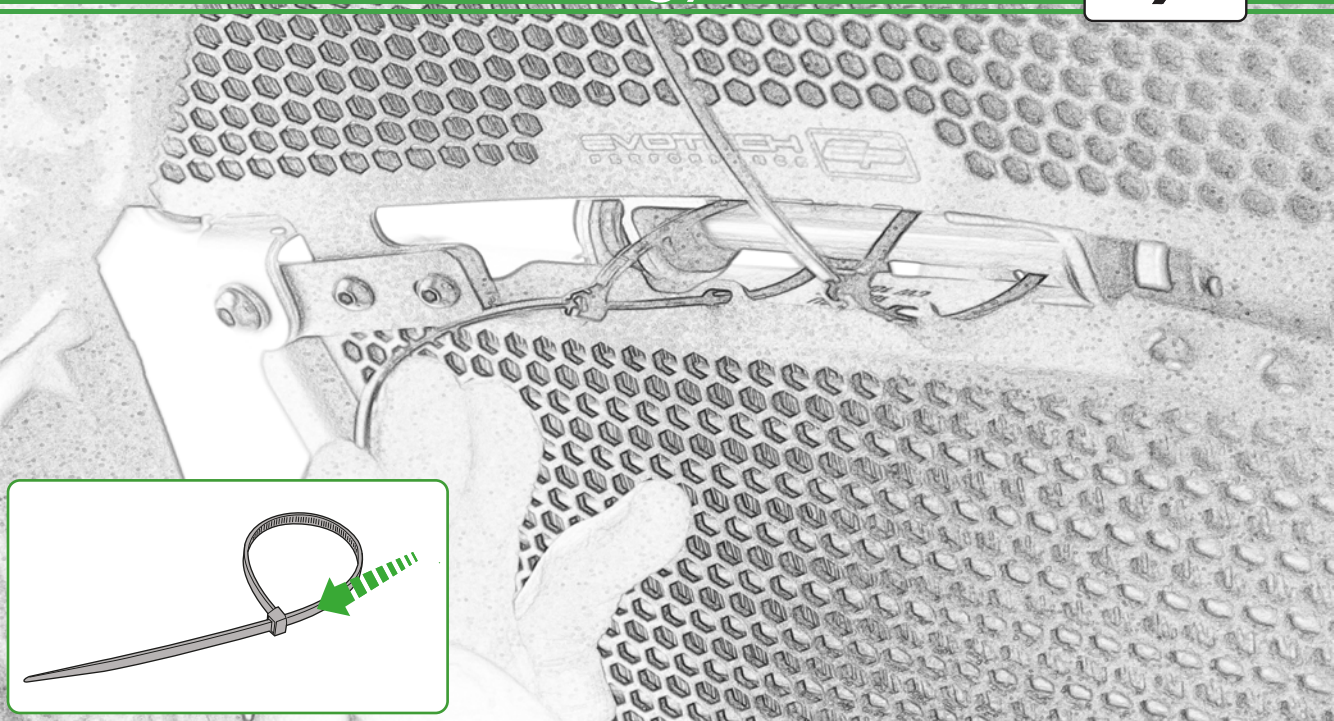

EVOTECH
PERFORMANCE

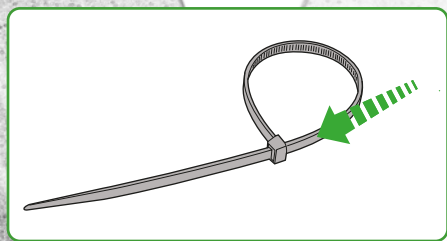

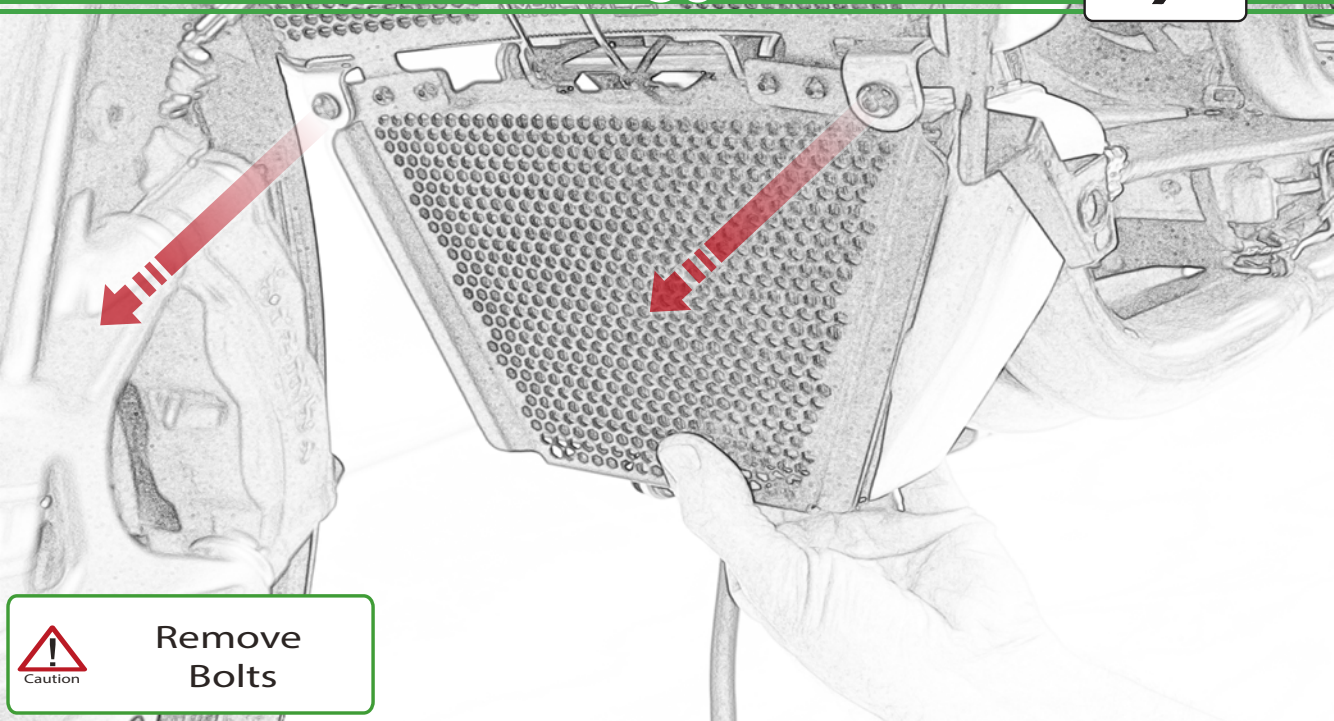

Caution

Remove
Bolts

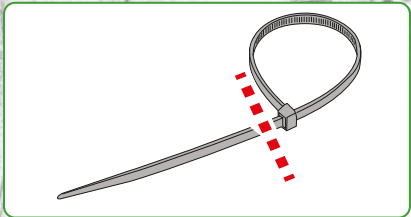
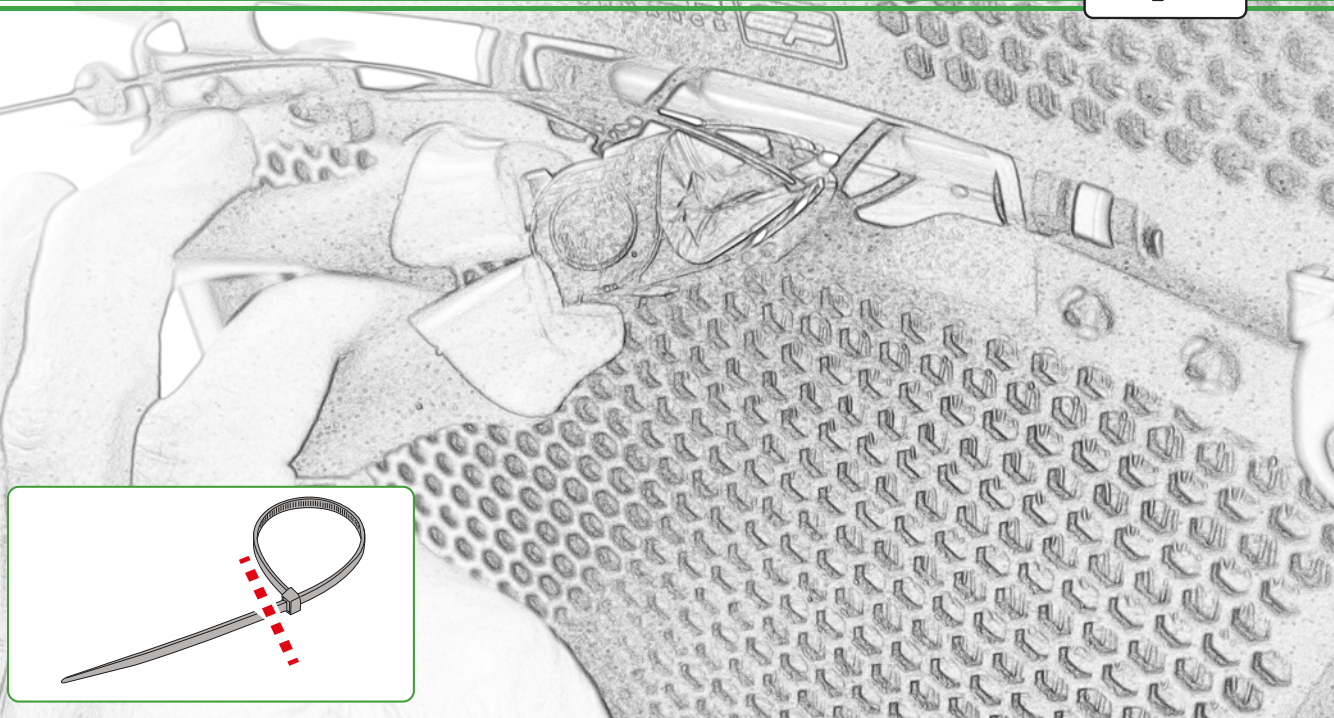



Reverse Stages

24 - 19



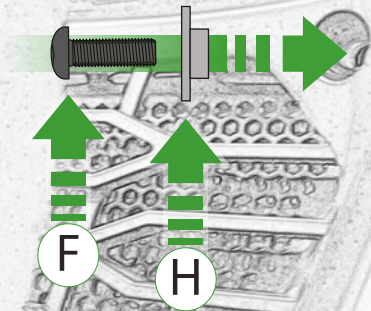

Repeat
Both Sides

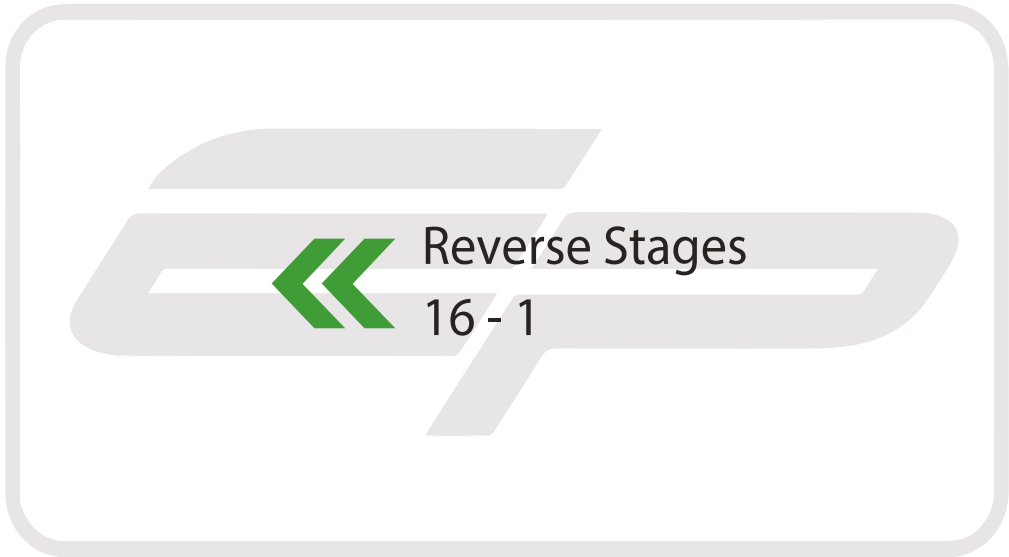



ESSENTIAL CHECKS

It is recommended that periodic inspections are made to ensure that dirt and debris have not become trapped between the guard and the radiator/oil cooler. Such dirt and debris would reduce the cooling efficiency of the radiator/oil cooler.

It is recommended that periodic inspections are made to ensure that all fixings are fully tightend.



EVOTECH®
P E R F O R M A N C E

www.evotech-performance.com